



**MSA NORTHERN REGIONS
STANDING SUPPLEMENTARY
REGULATIONS**

OFF-ROAD CAR

VERSION 4

12 May 2026

WWW.MOTORSPORT.CO.ZA

REGULATIONS AND SPECIFICATIONS FOR THE 2026 MSA NORTHERN REGIONS OFF-ROAD CAR RACING CHAMPIONSHIP REFERRED TO AS THE OFF-ROAD NORTH SERIES

REVIEW AND AMENDMENTS

Amendments and updates to the Rules will be recorded in the Amendment Record, detailing the updated version, date of approval of the amendment and a summary of the amendment. The updated version of the Rules will be published by Motorsport South Africa (hereinafter referred to as *MSA*) at least seven (7) days prior to the next event being held unless a shorter notice period is approved by MSA.

Modified ART	Pg	Date Applicable	Date of Publication	Clarifications
50.3	54	11/05/2026	11/05/2026	Restrictor for Century CR6 4x2 7 l pushrod V8 NA
3.7	4	07/05/2026	07/05/2026	Regulation Amendment
2.9 (a)	3	10/02/2026	10/02/2026	Regulation Addition
6.21	7	10/02/2026	10/02/2026	Regulation Addition
20.1.8 (d)	20	10/02/2026	10/02/2026	Regulation Addition
32.10	26	10/02/2026	10/02/2026	Numbering Amendment
32.10.2	26	10/02/2026	10/02/2026	Dispensation for FIA Vehicle Category to increase RON.

CONTENTS

Headings and sub-headings in this index are for convenience only and shall not be used in interpretation of any of the clauses.

PART 1 – APPLICABLE TO ALL EVENTS

1. VALIDITY OF THE REGULATIONS AND CONTROLLERS

1.1 Applicable period.....	1
1.2 Controllers	1

2. ELIGIBILITY OF COMPETITORS AND ENTRANTS

2.1 Domicile	1
2.2 Licences	1
2.3 Crew	1
2.4 Entries	1-2
2.5 Safety apparel & equipment	2-3
2.5.1 Helmets	2
2.5.2 Safety harnesses.....	2
2.5.3 Protective clothing	2
2.5.4 Neck restraints / neck braces	2
2.6 Drinking fluid	2
2.7 First aid kit	2-3
2.8 GPS, tracking & screamers.....	3
2.9 tracking units	4
2.10 Screamers	4
2.11 Competitors' briefing	3-4
2.12 Monitoring Tools.....	4

3. ELIGIBILITY OF VEHICLES

3.1 Series decals	4
3.2 Sponsors' decals	4
3.3 Competitors' names	4
3.4 Competition numbers.....	4
3.5 Warning triangles & medical boards	4
3.6 Scrutineering form / self-scrutineering form	4
3.7 Requirement for vehicles to be registered.....	4

4. ROUTE MARKING

4.1 "Day glo" markers.....	4
4.2 Route marking standards	4-5
4.3 Exceptions to route marking standards.....	5
4.4 Danger boards / "Xmas trees"	5
4.5 "No Go" areas	5
4.6 Start / finish area	5

5. ROUTE

5.1 Route design	5
5.2 Contravening the flow of traffic	5
5.3 Minimum and maximum distances	5
5.4 Maximum speed limit.....	5

6. ROAD BOOKS

6.1 Distribution of road books	5
6.2 Consistency	5-6
6.3 Total mileage	6
6.4 Intermediate distance.....	6
6.5 Required direction	6
6.6 Other tracks	6
6.7 Distance indicator pin	6
6.8 Dominant characteristic.....	6
6.9 Second aspect to instruction	6
6.10 Multiple humps	6
6.11 Measurement – distance indicator pin.....	6
6.12 Intermediate distances	6
6.13 Main track	6
6.14 Indication of Stops	6
6.15 Levels of caution	6
6.16 No duplication of instructions	6
6.17 "Off Piste"	6
6.18 Villages, settlements & farmhouses	6
6.19 Indication of angle	6
6.20 Cap Heading	6
6.21 Road book legend	7
6.22 Road book examples.....	8-9

7. ROUTE DIRECTION AND DEVIATION

7.1 Opposing the flow of traffic	10
7.2 Leaving the route	10
7.3 Deviation from the route	10
7.3.1 Minor deviation from the route	10
7.3.2 Major deviation from the route	10
7.3.3 Time advantage	10
7.4 Rejoining the route	10
7.4.1 Backtracking or rejoining the route.....	10
7.5 Corner cutting	10

8. CONTROLS

8.1 Identification of controls.....	10
8.2 Timed control	10
8.3 Control area	10 - 11
8.4 Standard signs	11
8.4.1 Danger	11
8.4.2 Stop sign	11
8.4.3 Marshal	11
8.4.4 Crossing	11
8.4.5 Light check control.....	11 - 12
8.4.6 Speed controls	12
8.4.7 Traffic Regulations	12

9. CLASSIFICATION AND TIME BARS

9.1 Classification	12
9.2 Qualifying classification	12
9.3 Racing section classification	13
9.4 Marathon event	13
9.5 Time back	13
9.6 Classification of ties	13
9.7 Time bar/s	13
9.8 Imposition of penalties.....	13
9.9 Competitor's right to see any material.....	14

10. DECONTROLLED SECTIONS / SECTIONS ON PUBLIC ROADS

10.1 Decontrolled sections / sections.....	14
10.2 Decontrol and procedure.....	14

11. ROAD AND RAILWAY CROSSINGS AND STOPS

11.1 Indication of a road or railway crossings	14
11.2 Stop sign	14
11.3 Definition of a stop	14
11.4 Responsibility of competitors	14
11.5 Missing stop board/s	14
11.6 Penalty for contraventions	14

12. PRE- AND POST-RACE

12.1 Pre-race line-up.....	14 - 15
12.2 GPS activation	15
12.3 Post-race paddock	15

13. OUTSIDE ASSISTANCE | MEDICAL/FIRE ASSISTANCE | CREW

13.1 Outside assistance	15
13.2 Medical / Fire assistance	15
13.3 Service personnel.....	15

14. PRE-RACE PRACTISING | AERIAL OBSERVATION

USE OF DRONES

14.1 Pre-race practising	16
14.2 Aerial observation.....	16
14.3 Use of drones	16

15. YELLOW / WHITE LIGHTS

15.1 Light check point	16
15.2 Failure to repair a yellow light.....	16
15.3 Failure to repair a white light	16

16. START ORDER

16.1 Qualifying	16
16.2 Seeding system.....	16

17. UNSPORTSMANLIKE CONDUCT

17.1 Overtaking, bumping & barging	16
17.2 Intentionally blocking.....	16
17.3 Obligation to report unsportsmanlike conduct	17
17.4 Clerk of the Course's rights	17

18. REFUEL

18.1 Refuel points & distance	17
18.2 Refuelling only permitted at designated points	17
18.3 Refuelling procedure	17
18.4 Designated Refuel Zone	17

19. ACCIDENTS | MEDICAL WARNING BOARDS | INCIDENTS | RETIREMENTS | MISDEMEANOURS

19.1 Accidents	18
19.2 Use of medical warning boards.....	18
19.3 Incidents	18 - 19
19.4 Retirements	19
19.5 Misdemeanours	19

20. PENALTIES

20.1 Penalties imposed without a hearing.....	19
20.1.1 Five (5) minutes	19
20.1.2 Ten (10) minutes.....	19
20.1.3 Fifteen (15) minutes	19
20.1.4 Thirty (30) minutes	20
20.1.5 Sixty (60) minutes	20
20.1.6 Exclusion	20
20.1.7 One thousand rand fine	20
20.1.8 Two thousand rand fine.....	20
20.2 Penalties subject to the necessity of a hearing	21
20.3 Penalties that may be imposed by the COC.....	21

PART II – CHAMPIONSHIPS

21. ELIGIBILITY OF COMPETITORS

22. CATEGORIES AND CLASSES

22.1 Categories and Classes.....	22
22.2 Classes	22
22.3 Classic club non-Championship Class.....	22

23. 2026 CHAMPIONSHIP SERIES..... 22

24. POINTS SCORING

24.1 Category Championship scoring	22
24.2 Class Championship scoring.....	22

24.3 Exclusion	22
24.4 Start points	22
24.5 Category and Class points scale	22

25. COMPETITORS INVOLVED IN ORGANISING EVENTS. 22

26. MINIMUM NUMBER OF STARTERS..... 22

27. EVENTS TO COUNT

28. AWARDS

29. SEPARATION OF TIES

PART III – TECHNICAL REGULATIONS

31. GENERAL REQUIREMENTS 24 - 25

32. DEFINITIONS

32.1	Group N engine.....	25
32.2	Modified engine.....	25
32.3	A re-engined vehicle.....	25
32.4	Intake manifold.....	25
32.4.1	Petrol engines.....	25
32.4.2	Diesel engines.....	25
32.5	McPherson suspension.....	25
32.6	Suspension travel measurement.....	25-26
32.7	Bump & droop stops.....	26
32.8	Anti-tramp rods.....	26
32.9	Technical passport.....	26
32.10	Fuel for all Classes.....	26

33. PERFORMANCE CONTROLS

33.1	Minimum weights.....	26
Note	26
33.1.1	Provisions.....	27
33.2	Power output & restrictions.....	27
33.2.1	Right to impose balance of performance.....	27
33.2.2	Air intake restrictors.....	27
33.2.3	Induction air.....	27
33.2.4	Forced induction engines.....	27
33.2.5	Stall test.....	27
33.2.6	Non-compliance.....	27
33.2.7	Sealing of restrictors.....	27
33.2.8	Restrictors.....	27
33.2.9	Classes D & E.....	27
33.2.10	Modified diesel engines not allowed.....	27
33.2.11	Restrictor sizes.....	27

34. EXHAUST SYSTEMS

34.1	Fitment.....	27
34.2	Fire prevention.....	27
34.3	Engine management systems / no flames ..	27-28

35. WINDOWS, SAFETY NETS, MIRRORS, CUTTERS

35.1	Side doors / side openings.....	28
35.2	Safety nets.....	28
35.3	Polycarbonate side windows.....	28
35.4	Life hammer / blade / knife.....	28
35.5	Rearview mirrors.....	28

36. FIRE EXTINGUISHERS

36.1	Minimum requirements.....	28-29
------	---------------------------	-------

37. FUEL TANKS

37.1	Fuel tank standards.....	29
37.2	Protection.....	29
37.3	Mounting of fuel tanks.....	29
37.4	Fuel lines and breather pipes.....	29
37.5	No fuel in loose containers.....	29

38. BATTERIES | LIGHTING | ELECTRICAL

38.1	Batteries.....	29
38.2	Battery isolator switch.....	29
38.3	Ignition coils.....	29
38.4	White lights.....	29
38.5	Yellow lights.....	29-30

39. SAFETY BELTS

39.1	Belts.....	30
39.2	Installation.....	30
	Drawing 253-61.....	30
	Drawing 253-66.....	30
	Drawing 253-67.....	30
39.3	Principles of mounting.....	31
39.3.1	General mounting system.....	31
	Drawing 253-62.....	31
39.3.2	Shoulder strap mounting.....	31
	Drawing 253-63.....	31
39.3.3	Crotch strap mounting.....	31
	Drawing 253-64.....	31
39.4	Use.....	31
39.5	Note – not permitted to mix parts.....	32

40. SEATS & SEAT MOUNTINGS

40.1	Anchorage points for fixing the seat supports.....	32
	Drawing 253-65B.....	32
40.2	Fixing of the seat supports.....	32
	Drawing 253-65.....	32
40.3	Quick release systems.....	21
40.4	Attachment of seat.....	32
40.5	Minimum thickness of support and counter plates.....	32
40.6	Homologation.....	32

41. CHASSIS & SAFETY CAGE

41.1	Requirements.....	33
	Drawings 253-1 - 253-3.....	33
41.2	General.....	33-34
41.2.1	Safety cage compulsory.....	33-34
41.2.2	Safety cage may be.....	34
41.2.3	Tubes must not carry fluids / other item/s.....	34
41.2.4	Must not unduly impede entry / exit.....	34
41.3	Definitions.....	34
41.3.1	Safety cage.....	34
41.3.2	Roll bar.....	34
41.3.3	Main roll bar.....	34
41.3.4	Front roll bar.....	34
41.3.5	Lateral roll bar.....	34
41.3.6	Lateral half-roll bar.....	34
41.3.7	Longitudinal member.....	34
41.3.8	Transverse member.....	34
41.3.9	Diagonal member.....	34
41.3.10	Removable members.....	34
41.3.11	Cage reinforcement.....	34
41.3.12	Mounting foot.....	34
41.3.13	Reinforcement plate.....	34

41.3.14 Gusset	34-35
Drawing 253-34	35
41.4 Specifications	35
41.4.1 Basic structure.....	35

41.4.2 Design	35-43
41.4.3 Material specifications	44
41.4.4 Guidance on welding	44
41.4.5 Protective padding	44

PART IV – VEHICLE CLASSES

42. SPECIAL & SIDE BY SIDE VEHICLE CATEGORIES CLASSES

Notes:	45
42.1 Purchase or construction of new vehicles	45
42.2 Crew	45

43. GENERAL REGULATIONS

ALL SPECIAL & SIDE BY SIDE VEHICLES

43.1 Protruding metal parts.....	45
43.2 Towing eyes	45
43.3 Materials	45
43.4 Air cleaner system.....	45
43.5 Traction-, launch- or vector-control restrictions.....	45
43.6 On-board tyre deflation/inflation systems	45
43.7 On-board vehicle jacking systems prohibited.....	45
43.8 Telemetry prohibited	45
43.9 Fasteners – ferrous materials only	45
43.10 On-board fire protection system	45
43.11 Communication & GPS devices.....	45
43.12 Number of crew members.....	45
43.13 Spare wheels securely fastened.....	45
43.14 Safety cage	45-46
43.15 Fuel	46
43.16 Speed limits	46

44. CLASS A | SPECIAL VEHICLES – TWO-WHEEL DRIVE

44.1 Chassis / suspension restrictions	46
44.2 Body	46
44.3 Engines	46
44.4 Transmission	46

45 CLASS B | SPECIAL VEHICLES – TWO-WHEEL DRIVE

45.1 Engines	46
45.2 Chassis, body, and suspension	46
45.3 Induction air or weight.....	46
45.4 Transmission	46

46 CLASS P | SPECIAL VEHICLE – TWO-WHEEL DRIVE

46.1 Chassis and suspension.....	47
46.2 Body	47
46.3 Exhaust manifold and systems.....	47
46.4 Transmission	47

47 CLASS G (SXS) | SIDE BY SIDE VEHICLES

47.1 Sporting Regulations: Side by Side vehicles	47
47.1.1 Class G will fall into Category Side by Side	47
47.1.2 ART 47	47
47.1.3 All SXS vehicles must comply.....	47
47.1.4 Balance of performance	47
47.1.5 Crew	47
47.1.6 Maximum speed.....	47
47.1.7 Weight	47
47.1.8 Number board	47-48
47.2 Vehicle technical Regulations – SXS MSA	48
47.2.1 Vehicles	48
47.2.2 Engine	48-49
47.2.3 Transmission / drive line	49
47.2.4 Braking system	49
47.2.5 Electrical system.....	49
47.2.6 Suspension and steering	49-50
47.2.7 Wheels and tyres.....	50
47.2.8 Chassis	50
47.2.9 Body	50
47.2.10 Fuel system	50-51
47.2.11 Auxiliaries	51
47.3 Vehicle technical Regulations – SXS FIA.....	51
47.3.1 Regulations applicable Group T3.....	51
47.3.2 Regulations applicable Group T4.....	51
47.3.3 Balance of performance	51

48. PRODUCTION & FIA VEHICLE CATEGORIES & CLASSES

48.1 Purchase or construction of a new vehicle	52
48.2 Crew	52

49 GENERAL REGULATIONS – PRODUCTION & FIA VEHICLES

49.1 Aerodynamic device / variation in body shape	52
49.2 Skid plates	52
49.3 Additional fluid coolers	52
49.4 Mud flaps	52
49.5 Bush deflector bars or cables.....	52
49.6 Side protection bars	52
49.7 Towing eyes	52
49.8 Materials	52
49.9 Traction, launch or vector-control, ABS, Electronically Controlled active suspension	52

49.10	Air cleaner system.....	52
49.11	On-board tyre deflation/inflation system.....	52
49.12	On-board vehicle jacking system	52
49.13	Telemetry & on-board data logging.....	52
49.14	Fasteners – ferrous materials only	52
49.15	On-board fire protection system	52
49.16	Communication & GPS equipment	52
49.17	Crew	52
49.18	Tyres	52
49.19	Steering multipliers.....	52
49.20	Re-engined vehicles	53
49.21	Spare wheels secured	53
49.22	Windscreens	53
49.23	Fuel	53
49.24	Speed limits	53

50. FIA VEHICLE CATEGORY

51. CLASS T | PRODUCTION VEHICLES, 5-LITRES 4WD

51.1	Engines	54
51.2	Transmission / Driveline	54-55
51.3	Brake system	55
51.4	Suspension	55-56
51.5	Steering	56
51.6	Body and chassis.....	56-58
51.7	Fuel System	58

52 CLASS S | PRODUCTION VEHICLES, 4-LITRES – 4WD

52.1	General	58
52.2	Engines	58-59
52.3	Transmission / driveline.....	59
52.4	Brake system	59
52.5	Suspension	59-60
52.6	Steering	60-61
52.7	Wheels, rims & tyres.....	61
52.8	Body & chassis	61-62
52.9	Fuel system	62
52.10	Electrical system	62
52.11	Cooling system.....	62

53 CLASS D | PRODUCTION VEHICLES WITH CHASSIS, 4L

53.1	Engine	63
53.2	Transmission / driveline	63
53.3	Brake system	63
53.4	Electrical system	63
53.5	Suspension	63-64
53.6	Rims / tyres	64
53.7	Chassis	64
53.8	Body	64
53.9	Fuel system	65
53.10	Crew	65
53.11	Minimum weight & air intake restrictors.....	65

54. CLASS E | PRODUCTION VEHICLES WITH CHASSIS 3L

54.1	Engine	65
54.2	Transmission / drive line.....	65
54.3	Brake system	65
54.4	Electrical system	65
54.5	Suspension	66
54.6	Rims / tyres	66
54.7	Steering	66
54.8	Chassis	66
54.9	Body	66
54.10	Fuel system	66
54.11	Crew	66
54.12	Minimum weights & air intake restrictors	66

55 CLASSIC CLUB CLASS

Note	67
55.1 Classic club Class eligibility.....	67
55.2 Rights of the Controllers	67

ADDENDA

Addendum 1	68
Addendum 2	69
Addendum 3	70

PART I – APPLICABLE TO ALL EVENTS

1. VALIDITY OF THE REGULATIONS AND CONTROLLERS OF THE CHAMPIONSHIP

- 1.1 Applicable for the calendar year 2026.
- 1.2 The Controllers of the Championship shall be the MSA Northern Regions Regional Motorsport Committee.

2. ELIGIBILITY OF COMPETITORS & ENTRANTS

- 2.1 The Off-Road North Championship (hereinafter referred to as the Championship) is open to any competitor holding a valid MSA competition licence with the minimum status being **Regional Off-Road Racing for Regional classes** and Club status for Club Championship classes or start permission from their home ASN irrespective of where they are domiciled. *Refer GCR 60*

- 2.1.1 Only competitors domiciled in the Northern Regions will be eligible to be awarded Northern Regions Colours.
- 2.1.2 No competitor shall be permitted to compete in an event unless he/she has satisfied the relevant officials that the following is in order.

2.2 Licences

All competitors must hold a current MSA Competition Licence valid for the event with the minimum of Regional Status for the Regional Championship class and a Club status for the club championship status classes. Electronic copies of MSA Competition Licences must be submitted together with the Entry Form for the event.

- 2.2.1 Where the entrant is not a member of the vehicle's crew, an MSA Entrant's Licence must be taken out prior to entry, failing which the entrant's name will not be published on any event documentation. *Refer GCR 22*
- 2.2.2 Competitors aged under seventeen (17) years may only obtain a Competition Licence endorsed for Navigational purposes. Competitors may compete as a navigator from the year in which they turn fourteen (14) years.
- 2.2.3 Any competitor who will be in control of a vehicle during an event must be in possession of a valid car Drivers' Licence, or a valid car Learners' Licence provided he/she is accompanied at all times by a crew member with a valid car Drivers' Licence. *Refer GCR 127 B).*
- 2.2.4 Competitors aged seventeen (17) and older in possession of a Learner's or Driver's Licence for cars may be issued with a Competition Licence permitting the competitor to drive a vehicle failing

which licences must be endorsed for Navigation only. Any competitor in possession of a Licence endorsed as a Navigator may, however, drive a vehicle on private property if such conduct is authorised by the MSA Northern Regions Regional Committee and MSA.

2.3 Crew

- 2.3.1 The person, or persons, nominated on the Entry Form and carried in the vehicle are deemed to be its crew.
- 2.3.2 Should the SRs for an Event Permit allow a change of crew / vehicle, such change may only be permitted prior to the start of the first competitive section for the event. *Refer GCRs 99 (vii) & 238.*
- 2.3.3 A competitor may only be nominated as the member of one (1) crew during an event.
- 2.3.4 The nominated crew members should be in the vehicle at all times whilst racing. Should a member of the crew not be present in the vehicle whilst racing the crew will be deemed to have retired from the event. *Refer ART 19.4*
- 2.3.5 The crew of a vehicle may include a nominated Second Driver or Second Navigator, but not both. For purposes of seeding and start orders the driver who will be completing Qualifying must be nominated as the First Driver on the online entry form.
- 2.3.6 Where the nominated crew includes either a Second Driver or Second Navigator a crew change may only take place at the start of any Racing Section or at the Designated Service Point (DSP). The onus is on the crew to advise the Clerk of the Course (COC), in writing, prior to the Competitors' Briefing when the change of Driver or Navigator will take place.

2.4 Entries

- 2.4.1 All competitors must have submitted a properly completed online entry form.
- 2.4.2 An entry will only be accepted if the documentation below is received prior to the close of entries:
 - a) online entry form completed in full.
 - b) online self-scrutineering form completed in full.
 - c) electronic copies of the crew's MSA Competition Licences and Provincial Drivers' Licences.
 - d) Payment of Entry Fee.

2.4.3 Any entrant or competitor who submits an online entry without all the required signatures shall sign the Entry Form, or submit a signed copy of the Entry Form, prior to Competitors' Briefing. *GCR 96*

2.4.4 a) For Regional Championship events entries will close no later than seven (7) days prior to the event. *Refer GCR 104*

b) Entry Fees

Entry fees for 2026 events will be as set out below; the fee includes tracking unit rental fee of R250.

Entry Fee:	1-day events	2-day events
FIA T1+	R 5 000.00	R 9 000.00
All other	R 3 500.00	R 7 000.00
Classic Club	R 1 750.00	R 3 000.00

2.4.5 Should a crew be unsure whether they will be able to compete in an event they should nevertheless submit an entry together with a non-refundable administration fee of Five Hundred Rands (R500.00). Should they be able to compete the balance of the entry fee is to be paid by 17:00 on the day preceding the event. Should they be unable to compete they should advise the Secretary of the Meeting accordingly, in writing, by no later than 17:00 on the day preceding the event failing which they will be liable for payment of the full entry fee.

2.4.6 Postponement, abandonment, or cancellation of competition *GCRs 62, 152 (vii), 156 vi), 244, 273 (ii)*
In the event of a postponement, abandonment or cancellation of a scheduled meeting or a competition forming part of a meeting, the Organisers reserve the right to apply the applicable below stated provision/s:

a) Postponement – Should an event be postponed prior to the start of the event, and it is possible to reschedule the event to another date, entries already received/lodged for the postponed event will be reallocated to the rescheduled event. If for any reason this is not possible, entry fees may be partially or fully refunded.

b) Abandonment – Once an event has officially started, *Refer GCR 31 & 261*, and is abandoned due to *Force Majeure* or safety concerns, no entry fee refunds will be made.

c) Cancellation – If an event is cancelled for any reason prior to its start, entries will be partially or fully refunded – *Refer GCR 244*

2.5 Safety apparel and equipment

Competitors' attention is drawn to *GCR 239*

2.5.1 Crash Helmets

a) All crew members are required to wear an approved crash helmet suitable for motor vehicles on all racing and/or competitive sections. Crash helmets must comply with *GCR 239*.

b) Motorcycle crash helmets are not permitted.

c) Crash helmets shall be in good condition and not show any signs of damage, cracking, worn webbing, etc.

d) Crash helmets are to be presented for inspection on request at pre-, and/or post-event scrutineering.

2.5.2 Safety harnesses

a) Safety harnesses shall comply with *GCR 239 & Part III - Technical Regulations and Specifications* of these Regulations.

b) Safety harnesses are to be worn by all competitors, properly fastened, at all times whilst the vehicle is moving.

2.5.3 Protective clothing

a) All crew members must wear approved protective clothing from ankles to neck to wrists with a minimum standard of a flame resistant overall during all competitive racing sections. *Refer GCR 239*

b) It is strongly recommended that suitable flame-resistant underwear is also worn.

2.5.4 Neck restraints / neck braces

a) It is compulsory for all crew members in o wear an approved Frontal Head Restraint (neck brace). The approved Frontal Head Restraints include the HANS and Simpson Hybrid as sanction by the *FIA Technical List No. 29*.

b) Reserved

c) Only in exceptional circumstances, where a medical doctor's report is submitted, will an exemption to this Regulation be considered. Such exemption may only be approved by the COC, in consultation with the Chief Medical Officer (CMO).

2.6 All vehicles are to carry at least one (1) litre of drinking fluid per crew member at the start of each day's racing.

2.7 All vehicles are to be equipped with a **first aid kit** which shall contain a minimum of the following:

1 X Space Blanket per crew member

1 X Triangular bandage

1 X 50mm X 70mm first aid dressing pad

1 X 50mm X 200mm first aid dressing pad

1 X 8cm stretch bandage

4 X Band Aid type strips

4 X Neatseal type plasters (2 X large, 2 X small)
The first aid kit shall be clean, in good condition and not more than two (2) years old.

2.8 GPS, tracking & screamers

The use of a GPS tracking device will be compulsory for all events. No crew may start an event without an operational GPS device fitted to the vehicle.

2.8.1 The GPS must comply with the following:

- a) Must be capable of loading custom maps onto an SD, Micro SD, or Garmin® data card.
- b) SD, Micro SD, and Garmin® data cards must be clearly marked with the crew's racing number in black ink on a white sticker.
- c) Must be capable of recording track logs with a minimum of ten thousand (10 000) points or more.
- d) Must be IPX7 rated (can handle wetness but not submersion).
- e) Ideally should take an external antenna to be mounted on top of the vehicle with cabling safely routed and protected. Units that do not have an external antenna capability should be mounted as much into the open as possible to obtain the best possible satellite coverage.
- f) Power to any GPS unit should be via direct dual fuses (positive and negative lines) from the battery.

2.8.2 In the event of a dispute as to the suitability and/or functionality of a crew's GPS unit the COC, in consultation with the Data Logging Manager, will decide whether the crew's GPS unit is acceptable.

2.8.3 The onus is on the competitor to ensure that their GPS unit has been zeroed before taking part in Qualifying and any Racing Section or Heat.

2.8.4 It is the responsibility of the competitor to present his/her GPS for download by the Data Logging Manager on completion of, or retirement from the event. Failure to comply will result in a fine of One Thousand Rand (R1 000.00). *Refer ART 20.1.7 (a).*

2.8.5 The COC shall be empowered to compare distances and, if required, will be empowered in consultation with the Data Logging Manager to download information from a crew's GPS Unit. *Refer ART 7.3*

2.8.6 Should a competitor not be able to present his GPS for download on completion of, or retirement from, a racing section due to the vehicle not yet having been recovered, the onus is on the competitor concerned to arrange with the Data Logging Manager to have the GPS data downloaded before the end of the event.

2.8.7 After finalisation of all formalities at an event the Data Logging Manager may download and examine a crew's data logs to establish whether a misdemeanour of any sort, or any transgression of the Rules is apparent by a competitor. Should a transgression have taken place this will be brought to the attention of the COC so that appropriate action may be taken if deemed necessary.

2.8.8 A levy of Five Hundred Rand (R500.00) will be charged for any crew requesting their own post-event GPS download. A competitor may not request the GPS download of another competitor.

2.8.9 Should it be discovered, and proven, that a competitor transgressed the Rules the COC may impose a penalty in terms of *GCR 157 & ART 20.*

2.8.10 GPS data must be preserved for a period of seven (7) days after the event. *Refer ART 20.1.8 (c)*

2.9 Tracking units

a) The use of the Committee appointed tracking company's units is compulsory for all competitors. The tracking device will incorporate an SOS button to be used only in the event of an accident to request medical assistance. Abuse of the SOS button will result in a fine. *Refer Art 20.1.8 (d).*

b) Failure to mount the device in accordance with the instructions of the tracking team will result in the competitor concerned being refused permission to start the event. *Refer ART 20.1.6 (c).*

2.10 Screamers

2.10.1 All vehicles shall be fitted with a Committee Approved screamer unit for safety reasons.

2.10.2 The screamer unit will be available to purchase at a cost of Two Thousand Rands (R2000). The Committee will provide competitors with details of the supplier via the website.

2.10.3 Failure to fit the screamer device or failure to have an operational screamer device fitted during an event will result in an **IMMEDIATE** exclusion. *Refer Art 20.1.6 (q).*

2.11 Competitors' briefing

2.11.1 Where a Competitors' Briefing is held, the time and place will be stipulated in the SRs, Final Instructions or by a Bulletin published on the Electronic Notice Board. The Organisers may issue binding verbal instructions, and/or changes to the road book at the briefing.

2.11.2 Attendance at Competitors' Briefings is compulsory for all competitors, and they will be required to sign an attendance register.

Any competitor who fails to sign the attendance register at the time that is collected will be deemed not to have attended the Competitors' Briefing. *GCR 87 (viii) & ART 20.1.1 (b)*.

2.12 Monitoring tools

The COC reserves the right to install and/or require the use of any monitoring tools in a vehicle and at places on the route at his discretion.

3. ELIGIBILITY OF VEHICLES

3.1 3.1.1 All vehicles must display the advertising decals as supplied by the Championship and/or event sponsors. *Refer GCR 246 (iii)* which makes it a condition of entry to display the sponsor's advertising material. Competitors / vehicles that do not comply with the provisions of this Article will not be permitted to start an event.

3.1.2 Any application for exemption from this Regulation must be made, in writing, to the Controllers who will make a ruling in consultation with the sponsor's representative.

3.2 **Competitors who fail to comply with the following provisions will not be permitted to start an event.**

3.2.1 Large Number Panel: if supplied, prominently displayed on each side of the vehicle.

3.2.2 Windscreen/Visor Decal: if supplied, displayed at the top of the windscreen, or on top of the visor, of all vehicles.

3.2.3 This decal may be trimmed to fit the profile of the windscreen, or visor, but must occupy 100% of the width of the windscreen, or visor.

3.2.4 Event Sponsor/s Decal/s: space must be provided on the side of the vehicle to prominently display the event sponsor/s decal/s.

3.2.5 Championship, and individual event sponsor/s decal/s will be supplied to competitors free of charge.

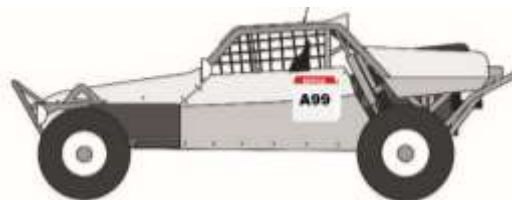

3.3 **Competitors' name/s**: A competitor's name, and blood group (where known), must appear on the front door of the vehicle underneath the window.

3.4 **Competition numbers**

3.4.1 All vehicles must display competition numbers displayed on the number panels as detailed in *Art 3.2.1*.

3.4.2 Numbers must be black on a white background and have a minimum dimension of 200mm X 130mm with a 30mm stroke width per digit.

3.4.3 All competitors will be required to obtain an annual competition number by logging on to the competitor portal and reserving their number.

3.5 All vehicles must carry **two (2) warning triangles and two (2) medical warning boards**, one (1) of which must be cloth, for the duration of the event. *Refer Art 20.1.3 (a)*.

3.6 All vehicles must conform to the vehicle presented at the initial scrutineering, which includes submission of the self-scrutineering form. The same chassis and engine block as indicated on the self-scrutineering form must be used from the initial scrutineering check until the finish of the event. *Refer Art 20.1.6 (d)*.

3.7 Competition vehicles participating in the 2026 MSA NR Regional Off-Road Car Championship events are not required to be road registered. However, competitors intending to compete in the SA National Rally-Raid Championship events must ensure full compliance with SSR 301 and GCR 69 and 70 b) ix).

4. ROUTE MARKING

4.1 All **route marking** must be done with "Day-Glo" markers.

4.1.1 Each marker must present a face of at least 100mm X 100mm to competitors.

4.2 4.1.2 Route marking must only be placed on the left-hand side of the track. A single red "Day-Glo" "confirmation" marker will be placed to confirm

the track and direction thereof.

4.2.1 Where the route is not obvious confirmation markers may be placed within suitable distances of one another.

- 4.2.2 Where a turn is indicated the following will apply:
- a) Double red "Day-Glo" "turn" markers placed 100m before the turn and again on the turn on the left for a left-hand turn and on the right for a right-hand turn.
 - b) Where routes run closely together in opposite directions a marshal and/or barrier tape is required.
 - c) "Day-Glo" markers facing competitors from the outgoing route shall be sprayed black or positioned in such a way that they are not visible to oncoming competitors.

4.3 Should there be a **change from the above**, such as the route being run in reverse, the confirmation markers will be on the right-hand side.

4.4 **Danger Boards/Xmas Trees** should only be used where a dangerous, or extreme change in terrain, takes place without warning.

4.4.1 Danger boards should have a minimum size of 400mm X 600mm high with an exclamation mark and should be erected approximately 100m before the hazard.

4.4.2 A "Xmas Tree" made out of barrier tape or "Day-Glo" markers must be erected at the actual danger point.

4.4.3 Where the route comes to a T-junction at which there is barbed wire or game fencing, this fencing should be clearly marked with barrier tape and/or "Day-Glo" markers indicating the direction of the turn.

4.5 **"No Go" areas** will be indicated with green "Day-Glo" markers.

4.6 Where possible the first 50m from the start and the last 50m to the finish are to be bunted / fenced to keep spectators off the route. Marshals are to be present to ensure good crowd control.

5. ROUTE

5.1 The route should be centred around the DSP. The route includes competitive racing sections as well as decontrolled sections.

5.2 Contravening the flow of traffic or smoking in the DSP by a competitor or member of their service crew. *Refer Art 20.1.1 (a).*

5.3 Minimum and maximum distance

5.3.1 The minimum distance for a Championship event is two hundred and fifty kilometres (250kms) and the maximum distance is three hundred and fifty kilometres (350kms) both distances including Qualifying, where applicable.

5.3.2 The only exception to this will be one (1) marathon event held per season run over two (2) days where the minimum distance will be four hundred kilometres (400kms) and the maximum distance five hundred kilometres (500kms) both distances including Qualifying sections, where applicable.

5.3.3 A tolerance of 10% may be allowed, dependent on available terrain.

5.4 Maximum speed limit

The maximum speed limit for all Classes, at all times is one hundred and seventy kilometres per hour (170km/h) with the exception of Class G (SXS vehicles) where the maximum speed limit is one hundred and forty kilometres per hour (140km/h). The maximum speed limit may not be exceeded. Refer ART 20.1.1 (h).

6. ROAD BOOKS

6.1 The Road Book/s, in electronic format, will be made available to competitors on the Competitor Portal no later than forty-eight (48) hours prior to the start of the event.

6.1.1 The Road Book/s will be the definitive document and takes preference over route marking.

6.1.2 Changes to the Road Book/s will be issued, in writing, by the COC and posted on the Electronic Notice Board.

6.2 The Organisers will make every effort to ensure the **consistency** of the Road Book.

6.2.1 Emergency contact numbers will be printed on the first page of the Road Book.

6.2.2 All pages of the Road Book will be numbered sequentially.

6.2.3 Every instruction will be numbered sequentially.

6.2.4 An instruction will be created where the route changes from the obvious route.

6.2.5 The Road Book will be divided into three (3) columns.

a) Column One will be used to display distances:

At the top of each row in Column One the Total Distance will be indicated.

At the bottom right of each row in Column One the Intermediate Distance will be indicated.

b) Column Two will have a picture / illustration of the instruction.

c) Column Three will contain any additional notes that the race organisers wish to bring to the competitors' attention.

6.2.6 Each page of the Road Book will have five (5) instructions per page.

6.2.7 The margins of the Road Book will be set.

6.2.8 The legend and text will be clearly legible and will be at least five millimetres (5mm) in height.

6.3 The **total mileage** will be indicated in Arial Bold, at a size of sixty-five (65) points, at the left top corner of the instruction, for example:

0.00

6.4 The odometer Intermediate Distance will be indicated in Arial Bold, at a size of forty-five (45) points, at the left bottom corner of the instruction, for example:

0.35

6.5 The line indicating the **required direction** will be a weighted six (6) point solid line, for example:



6.6 Any **other tracks** that need to be indicated will be in a thinner line weight, for example:



6.7 Diagrams may contain a short line with a dot at the end (**Distance Indicator Pin**) to indicate the point on the diagram to which the distances apply.

6.8 The Distance Indicator Pin will be placed at the most **dominant characteristic** of the instruction. (Where possible an identifiable landmark) and the distance between instructions is measured to this landmark. For example, if there is a 90° right turn, it will be on the corner of the turn.

6.9 Should there be a **second aspect** to one instruction, the distance is from the distance indicator pin to that of the second aspect. For example, if there is a 90° right turn and 120m further there is a split left, the 120m will be indicated in the picture column.

- 6.10 Where there are **two (2) or more dips or humps** in one picture the distances between them must be indicated.
- 6.11 The **Total Distance Indicator** will be measured from Start to Finish.
- 6.12 **Intermediate Distances** will be measured from instruction to instruction. Please note it is possible that distances do not add up to the total by ten (10m) metres due to rounding off.
- 6.13 Stay on the **main track** unless otherwise indicated in the Road Book.
- 6.14 All "**STOPS**" at road/railway crossings and district roads (public roads) as well as EXTREME changes to terrain (Danger Marking) will be indicated in the Road Book.
- 6.15 Danger will be indicated with **different levels of caution** (!, !!, !!!, !!!!).
- 6.16 Instructions will **not be duplicated** in the comments column, this column is purely for extra information.
- 6.17 "**Off Piste**" (previously referred to as "No Trail") sections where markers must be followed, will be indicated by a dotted line and single caution.
- 6.18 All villages, settlements, farmhouses, or homesteads, where competitors may encounter people or spectators will be indicated with a single caution.
- 6.19 The angle in relation to a gate, or opening in a fence, will be indicated, for example:







- 6.20 A **Cap Heading (bearing)** can be included in any road book instruction.

6.21 Road book legend

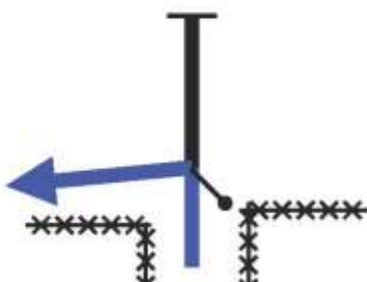
ROADBOOK LEXICON		
TRACKS	ABBREVIATIONS	SYMBOLS
Tarmac Road	BAD Bad	Barbed wire fence
Track / Piste	RP Rejoin	Fence
Off Track (HP)	BTW Between	Railroad
Low visible Track / Traces	MODIF Change from official	Restricted area
RO Road	NEW NOTE New note from official	Signboard
HP Off Track	Written as text	Animals
HP Off Track Forbidden	WAYPOINTS	Animals individual
FPP Follow principal track	Control WP	Dam
FRO Follow Road	Safety WP	Lake / water
SA Sandy	Waypoint Number	Mountain
GV Gravel	CONTROLS	Palm Tree
SAFETY	DSS Start selective section	River
Danger Level 1	ASS Arrival selective section	Riverbed
Danger Level 2	Stop for restart	Rocks
Danger Level 3	Fuel zone with authorised cat.	Tree
Global danger in the note	Assistance / service	Tree stumps
Start speed limit	ON TRACK	Vegetation / Crops
Finish speed limit	Bump	Water crossing
Stop	Dip	Barrels
Important	Compression	Buildings/ House
Red line under km = danger 2 in the note	Ditch	Cemetry
ABBREVIATIONS	Summit	Church / mosque
VG Vegetation	Above bridge	Heavy equipment
L/R Left and right	Under bridge	Kraal
R/L Right and left	Step up	Monument
onL On Left	Step down	Notable elements
onR On Right	Up hill / Down hill	Ruin / abandoned
kpL Keep to the Left	Cut danger	Silo/s
kpR Keep to the Right	Right or left over crest	Tanks
kpS Keep straight	Fence gate	Tunnel
-V Less visible *	Fence gate with cattle grid	Tyres
±V More/less visible *	Wall gate	Village
ALT Alterance / change	Wading / water crossing	Wall
/ During	Concrete pass	Water pump / borehole
IN In / into	SYMBOLS	Water trough
ET And / next	Bumpy	Windmill
A At	Bumpy / broken	Post / pole
CX Stone / stony	Collapse, ditch, ravine, etc.	Air valve
E3 Narrow	Lateral incline	Antenna
Q^T Quit / leave	Ruts	Electric line
.TJS Always	Slope	Electrical pole
NBX Many	Twisty / sinuous	High voltage pylon
IMP Imperative	Distance	Pipeline
EFF Collapsed	Towards / direction	Pipes
ORN Ruts	Hole	Stay wires

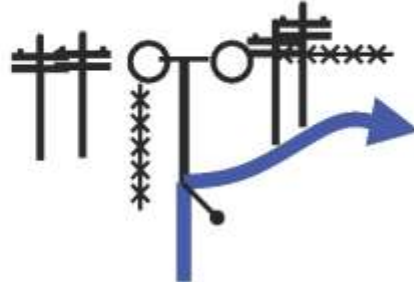



6.22 Road book examples

PAGE 10	TWINSTAR 500 MAIN RACE	KM TOTAL: 121
<p>41,58</p> <p>0,85 46</p>		
<p>42,79</p> <p>1,21 S 47</p>	<p>120M</p> 	<p>FOLLOW CROP LINE</p> <p>(12)</p>
<p>43,03</p> <p>0,24 S 48</p>		<p>(13)</p>
<p>43,34</p> <p>0,31 49</p>		
<p>44,17</p> <p>0,83 DZ 50</p>	<p>100M</p> 	<p>DONT GO STRAIGHT STAY WIRE</p> <p>80</p> <p>(14)</p>

PROXIMA NOTA
PROCH NOTE
NEXT NOTE

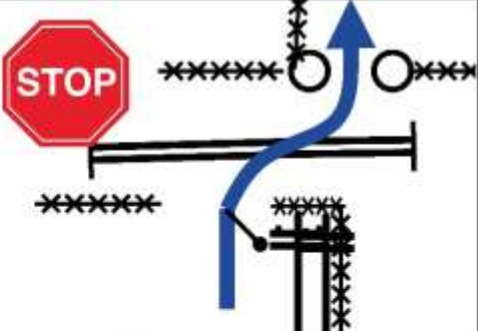
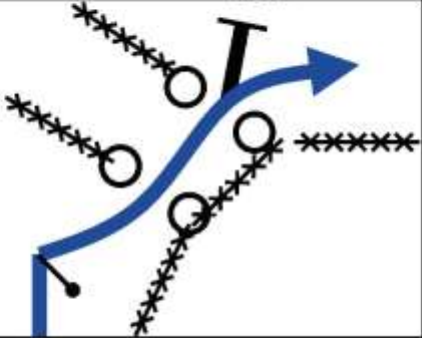
1,94

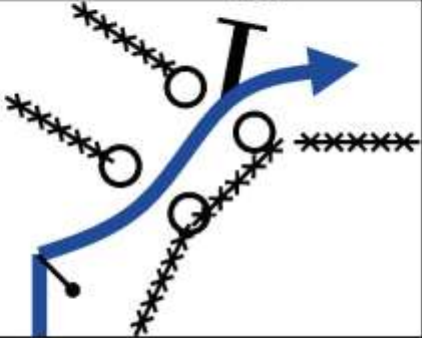
 Emergency Contacts | Medical - 072 831 6867 | Fire or Route 082 552 2689

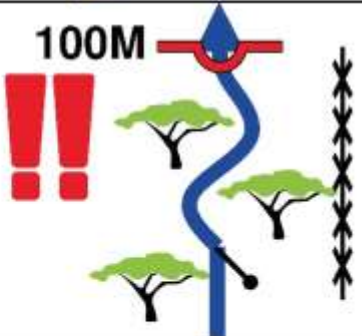
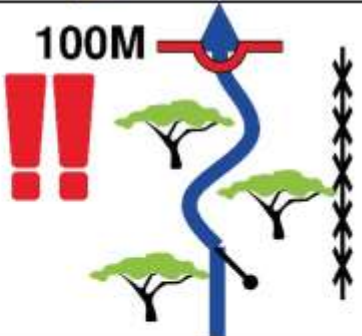
PAGE 19	PENTA 300 MAIN RACE	KM TOTAL: 111
<p>94,11</p>		
<p>0,80 91</p>		<p>QUALY JOIN</p>
<p>0,62 92</p>		<p>BEWARE AIR VALVES</p> 
<p>94,99</p> <p>0,26 ↓ 93</p>		<p>BEWARE AIR VALVES</p> 
<p>97,04</p>		
<p>2,05 94</p>		
<p>97,60</p> <p>0,56 95</p>		

PROXIMA NOTA
PROCH NOTE
NEXT NOTE

1,27



Emergency | Medical - 072 831 6867 | Fire or Route 082 552 2689



7. ROUTE DIRECTION AND DEVIATION

- 7.1** No competitor may drive on the route in a direction **opposing the flow** of competitors driving in the direction stipulated in the Road Book. *Refer ART 20.1.6 (e).*
- 7.2** A competitor may only **leave the designated route** when circumnavigating an obstruction, or overtaking, or when rendering assistance in terms of *ART 19.1*. This must be done by staying as close as possible to the route as indicated in the Road Book.
- 7.3** Deviation from the route shall be deemed to have taken place from the point where the competitor leaves the route to the point where the competitor first re-joins or cross the route whether or not an advantage in distance or time has been gained by such deviation. *Refer ART 2.8.5.*
- 7.3.1** Minor deviation from the route or failure to follow the Road Book instruction correctly: If, and where, a time advantage of less than sixty (60) seconds has been gained as recorded by the logged data, or a distance of one hundred (100m) metres or less has been gained as recorded by the logged data a five (5) minute penalty plus time advantage gained will be applied by the COC in consultation with the Data Logging Manager. *Refer ART 20.1.1 (c).*
- 7.3.2** Major deviation from the route or failure to follow the Road Book instruction correctly: If, and where a time advantage of more than sixty (60) seconds has been gained as recorded by the logged data, or a distance of more than one hundred (100m) metres is gained a fifteen (15) minute penalty plus the time advantage gained will be applied by the COC in consultation with the Data Logging Manager. *Refer ART 20.1.3 (b).*
- 7.3.3** Time advantage gained will be calculated taking the time of a competitor closely matched in speed through the correct route.
- 7.4** In the event of a competitor getting lost on the route the competitor shall correct the deviation by **re-joining the route** as close to the original point of deviation as is safely possible to avoid being penalised in terms of *ART 7.3* above.
- 7.4.1** When backtracking to find or re-join the correct route competitors shall drive slowly next to the road or track where possible and must exercise extreme caution so as not to meet competitors from the front who may follow the same incorrect track created by the first offender or meet competitors head-on on the correct route and travelling in the correct direction.

Competitors must ensure that the correct direction of flow is followed when re-joining the correct route safely. *Refer GCR 172, GCR 173, ART 20.1.6 (e) & ART 20.2.2.*

7.5 Corner cutting

Corner cutting or shortening the corner to the inside, or extending to the outside, is not permitted. Corner cutting usually takes place in cultivated or ploughed lands and upsets the landowners. A marker may be placed inside the corner in the vicinity of the corner apex, or outside the corner at the corner entrance/exit. Competitors are to drive around the outside of the apex corner marker or inside the entry and exit markers. Should a competitor drive on the wrong side of the corner marker, or flatten or take the marker out, a penalty of five (5) minutes per offence will be applied. More than three (3) corner cutting transgressions per event may lead to the COC increasing the penalty. The competitors logged data may be used as evidence. Penalties may be applied during, or after the event and the onus will be on the competitor to prove his innocence. *Refer ART 20.1.1 (g).*

8. CONTROLS

8.1 Controls will be identified by **control boards** and will be operated by the appointed event officials.

8.2 Timed control

8.2.1 A Timed Control will operate at the start and finish of every competitive racing section, e.g., the Start and End of Qualifying, Start and End of a competitive Racing Section, Start and End of a de-controlled section, entrance and exit of DSP and End of a Racing Section.

8.2.2 A Competitor's time of arrival at a Timed Control will be recorded by an official on a sequence sheet in hours, minutes and seconds and will be the official time used for purposes of calculating results.

8.2.3 Early departure from a Start Control ("jumped start") will carry a ten (10) minute penalty plus the time gained by departing early. *Refer ART 20.1.2 (a).*

8.2.4 Missing a control, or failure to stop at a control, or ignoring a control official's instruction will carry a sixty (60) minute penalty. *Refer ART 20.1.5 (b).*

8.3 Control area

The area between the first set of control boards, as recognisable by the letter M and thereafter by the STOP sign/s signifies the Control Area which is deemed to be a Parc Fermé. In this control area the following is not permitted:

8.3.1 No servicing or working on a vehicle. Should a vehicle break down in a control area it may only be pushed out far enough to clear the control area and to allow for the passage of other competitors. Thereafter *ART 13.1* applies.

8.3.2 No overtaking. When a competitor is stopped at a control official, and another competitor approaches, the second competitor may not pull up alongside the stationary competitor. The second competitor must wait for the control official to complete all formalities with the first competitor until he is called by the control official. No time allowance will be granted for the time spent waiting in a control area by a competitor. *Refer ART 20.1.3 (c)*.

8.3.3 A competitor may not enter a control from the opposite direction to the flow of traffic as indicated on the Road Book, this includes reversing into a control. *Refer ART 20.1.6 (e)*.

8.4 Standard Signs to be used on all events.

8.4.1 Danger: Black on a white background.

- This may be placed on a board with a minimum dimension of 600mm wide X 600mm high.
- This board should be displaying one hundred (100m) metres before a road crossing, marshal point, timed control, refuel or service area, and extreme change of terrain.
- Alternately a caution can be identified by numerous "Day-Glo" stickers forming a "Xmas Tree" to indicate danger.



8.4.2 STOP sign: White on a red background.

- Hexagonal shaped with a minimum dimension of 300mm wide X 300mm high.
- This sign should be placed on a board with a minimum dimension of 600mm wide X 600mm high.
- This board must be placed at road crossings, marshal points, light check controls and time controls.



8.4.3 Marshal

- Black M on a white background. The sign should be placed on a board with a minimum dimension of 600mm wide X 600mm high.
- This board should be placed fifty (50) metres before a marshal point. A STOP board must be placed at the marshal point.



8.4.4 Crossing: Black cross on a white background.

- This sign should be placed on a board with a minimum dimension of 600mm wide X 600mm high.
- This should be placed fifty (50m) metres before the road/railway crossing.



8.4.5 Light check control

- Round signs on white ABS plastic 300mm in diameter.
- "Light Check" in red lettering with "OK" in green lettering printed on the reverse side in such a way that when the board is turned over the letters face the right way up.
- This board will be mounted on a pole of not less than one (1m) metre in length so that the marshal can hold it out in front of a competing vehicle.
- If a light check control is situated at a road crossing it shall be situated at fifty (50m) metres after the crossing to avoid interference with the road crossing.
- Light check controls will be demarcated by a danger sign followed by a Marshal sign (M) at approximately fifty (50m) metres and the approximately fifty (50m) metres to the STOP and the marshal with the Light Check/OK sign.
- It is not compulsory to indicate the Light Check Control in the Road book, or any other navigational aide supplied by the Organisers to competitors.

- g) Competitors will be required to stop at the Light Check Control marshal and may only leave when the "OK" sign is shown. Failure to stop at the light check control or ignoring a light check control official's instruction carries a ten (10) minute penalty. Refer ART 20.1.3 (e).

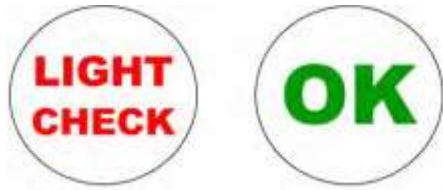

8.4.6 Speed controls

- All speed controls within a racing section will be indicated by a "Danger" warning board followed one hundred (100m) metres thereafter by a STOP board with the words "Speed Limit" indicated below.
- The delimitation of the speed limit will be indicated by a "Speed Limit" sign with a diagonal line through it.
- There may also be a speed limited posted on the GPS route as supplied.
- Where a speed limit is posted it may not be exceeded. Exceeding the speed limit as indicated on the Road Book, or on the GPS track, will incur a five (5) minute penalty. Refer ART 20.1.1 (d).
- No overtaking of race vehicles, except those that are stationary or proceeding very slowly, is permitted. Refer ART 20.1.5 (c).



8.4.7 Traffic Regulations in non-racing sections

- All National, Provincial and/or Local Traffic signs in non-racing sections will be indicated in the road book and governed by National, Provincial, or Local Traffic Regulations, Rules, and signage. Refer GCR 69
- The penalty for transgressing any Traffic Regulation (speed, stopping, overtaking, dangerous driving, etc.) is fifteen (15) minutes per infringement. Refer ART 20.1.3 (d).

9. CLASSIFICATION AND TIME BARS

9.1 Classification

To be classified as a finisher of an event the crew must start, and complete, the full distance of the event as specified in the road book within the time allowed prior to the imposition of any time bar/s.

- 9.1.1 In the event a crew does not finish Qualifying under its own power or is deemed a non-finisher of Qualifying the crew will be permitted to start the following Racing Section with the applicable penalty applied. Refer ART 9.2.5.

9.2 Qualifying classification

- 9.2.1 The Qualifying Start Order will be published at the start of the Competitors' Briefing / Start of the event. The Qualifying Starting Order will be determined by the COC taking the Series Seeding List into consideration with the proviso that the COC may, at his sole discretion, allocate any crew a higher or lower starting position than indicated by the Series Seeding List for safety reasons. Competitors in the Top Five positions will draw for their start position.

- 9.2.2 A crew's Qualifying finish time will be recorded by the officials at the end of the Qualifying.

- 9.2.3 A crew's Qualifying Elapsed Time will be calculated by deducting the crew's Qualifying start time from their Qualifying finish time.

- 9.2.4 Qualifying results will be calculated by adding the crew's Qualifying elapsed time, together any penalties incurred (where possible), and ranking crew from the crews from the least to the greatest total time. If two crews set the same time on the Qualifying Results the crew with the higher seeding will be allocated the higher starting position.

- 9.2.5 Any crew that does not finish the Qualifying, and any crew that finishes Qualifying with an elapsed time equal to or greater than one and a half (1½) times that of the fastest Qualifying elapsed time in their Class, will be classified as a non-finisher of Qualifying. non-finishers of Qualifying will be allocated a Qualifying elapsed time of one and half (1½) times the fastest Qualifying elapsed time in their Class.

- 9.2.6 Crews that entered the event, but did not start the Qualifying, will be allocated a Qualifying elapsed time of twice (2 times) the fastest Qualifying elapsed time in their Class.

- 9.2.7 If there are no Qualifying finishers in a Class the fastest Qualifying elapsed time referred to in clauses (e) and (f) above will be calculated using the time of the fastest crew in the next most appropriate Class at the discretion of the COC.

9.3 Racing section classification

9.3.1 Crews will start the Racing Section, or Heat, in the order established by the Qualifying Results with the fastest competitor starting first, followed by the second fastest competitor and so on.

9.3.2 The intervals for the Racing Section Start will be decided by the COC at his sole discretion.

9.3.3 Reserved

9.3.4 A crew's racing section elapsed time will be calculated by deducting their racing section start time from their racing section finish time.

9.3.5 A crew's total time for Qualifying and the Racing Section, together with any penalties imposed, will determine their overall time and final position. Crews will be ranked from the crew with the least to the greatest time.

9.3.6 Category and Class results will be ranked from the crew with the least to the greatest total time.

9.4 Marathon event

9.4.1 One (1) marathon event may be staged per season. Refer ART 5.3.2.

9.4.2 The event will consist of two (2) heats run on consecutive days with separate results issued per heat. The Qualifying Start Order for Heat 2, where Qualifying is held, will be determined by the final classification of Heat 1.

9.4.3 For trophy purposes only the results of Heat 1 and Heat 2 will be added together to produce overall results ranking crews from the crew with the least total time to the greatest total time.

9.5 Time back

9.5.1 Time back will only be considered under exceptional circumstances if a crew lose time due to an unforeseen circumstance where the route is temporarily blocked through human error, e.g., a tractor travelling on the route or deliberate blocking of the route.

9.5.2 Time back will not apply to instances of *Force Majeure* e.g., flooded rivers, rockfalls, blown over trees, etc. neither will it apply to mechanical failures, nor driving or navigational errors.

9.5.3 The onus is on the competitor to prove the time lost by presenting visual evidence from in-car camera footage. The footage must be taken from inside the vehicle, facing the route, and must include a time and date stamp as well as GPS pin, Road Book distance and instruction number. External camera footage will only be considered where the vehicle is clearly identifiable, and where the footage includes a time and date stamp and GPS location.

9.5.4 Time back will be considered at the sole discretion of the Clerk of the Course. Any request for Time back must be lodged within thirty (30) minutes of the affected crew completing the competitive section for which they are requesting compensation.

9.6 Classification of ties

9.6.1 In the event of a dead heat the crew who finished Qualifying in the higher position will be declared the winner.

9.7 Time bar/s

9.7.1 Time bars set to prevent slower competitors from proceeding on the route will be published in the SR's, Final Instruction or by a Bulletin published by the COC on the Electronic Notice Board.

9.7.2 The COC may extend any Time Bar by means of a Bulletin published on the Electronic Notice Board.

9.7.3 The DSP Time Bar will be applied at the DSP Exit.

9.8 Imposition of penalties

9.8.1 As far as possible and/or practical penalties incurred during Qualifying will be imposed on the Qualifying Results, with the exception of any penalties incurred in terms of ART 2.8 and/or ART 2.10. Penalties incurred during a Racing Section or Heat will be imposed on the Racing Section Results. All penalties incurred in terms of ART 2.8 and/or ART 2.10 will be applied on the overall results following the download of competitors' GPS data logs.

9.8.2 The results of an event will be published subject to the examination of GPS data logs in terms of ART 2.8.7 and ART 2.8.9 and subject to the examination of any incidents or footage arising from the event. The Data Logging Manager will examine data logs within seven (7) days of the event. Should the data logs or any footage or evidence reveal that there was a deviation from the route (*Refer ART 7.3*) or damage to any landowners' property or crops (*Refer ART 19.3.2*) the COC will be empowered to impose penalties, including time penalties, in accordance with ART 20 and amend the results of the event accordingly. Such amended results will be published on the Electronic Notice Board and shall be subject to protest in accordance with GCR 200.

9.8.3 Any transgression discovered after the results of the event are final, in terms of ART 9.8.2, may incur a penalty added to the crew's next event.

9.9 Note: Every competitor has the right, on written request, to see any written or printed matter, records, reports, GPS Tracks, timecards, or sequence sheets pertaining to their own entry during an event.

10. DECONTROLLED SECTIONS / SPEED ZONES / SECTIONS ON PUBLIC ROADS

10.1 Decontrolled sections / Speed Zones

10.1.1 Where the route of an event follows a district road, and this road has not been closed to normal traffic, competitors will be decontrolled and given an adequate time allowance to allow them to complete the decontrolled section whilst obeying all normal Traffic Rules or a speed zone will be applied whilst traversing a speed zone competitors must obey all normal Traffic Rules and follow the prescriptions of *Articles 10.1.2 and 10.2* below.

10.1.2 Decontrol and procedure

The COC, at his discretion, and as dictated by the route and events on the day, may impose a decontrol section during any racing section.

- a) A decontrol section will start at the point where the crew is issued with a Decontrol Timecard.
- b) The onus is on the crew to ensure that all times recorded on the Decontrol Timecard are correct.
- c) The onus is on the crew to calculate their own given times on the Decontrol Timecard and to ensure that they arrive timeously at various controls as indicated on the Decontrol Timecard.
- d) The Crew must report to all time controls in good time for the official to record their time on the sequence sheet and prepare the crew to start at the correct time as indicated on their Decontrol Timecard. *Refer ART 20.1.1 (e).*
- e) In the event that a crew arrive late, or out of sequence, at a start control or restart control, they will be started at the time, and in the order of arrival, at the discretion of the official at the restart control. No allowance will be given for time lost due to late arrival, or arrival out of sequence, at a start control.

10.2 The Outside Assistance rule will be applicable to all decontrolled or speed zone sections. *Refer ART 20.1.6 (p).*

11. ROAD AND RAILWAY CROSSINGS AND STOPS

11.1 Where the route crosses a road or railway line a board with a black cross on a white background must be erected fifty (50m) metres before the road, railway line or decontrol stop. The road or railway crossing, or decontrol stop must be indicated in the Road Book.

11.2 A STOP sign must be erected at the edge of the road or railway line or decontrol area and must be visible to competitors allowing sufficient time to stop. There must be a minimum of two (2) marshals at all crossings.

11.3 It is compulsory to stop where indicated. A stop is defined as the vehicle being stationary. The whole vehicle must stop before an imaginary line drawn between the two stop boards. Stopping in the middle of the road or right across is not safe. A stop is defined as a vehicle being stationary and not sliding with locked wheels. Taking the board/s out, will be regarded as not stopped. Having stopped before the boards, the competitor may move forward between the boards to cross the road/rail. *Refer ART 20.1.2 (c).*

11.4 Competitors must first make sure that it is safe to cross the road or railway line before proceeding, irrespective of whether an official, or member of the public, or any other person waves the crew through the onus is on the competitor to ascertain that it is safe to proceed.

11.5 Competitors are required to stop as indicated on the Road Book or on the GPS Track, whether the Stop Boards are present or not. Competitors who ignore the instruction in the Road Book, or on the GPS Track, will incur the same penalty as if the Stop Boards were in place. *Refer ART 20.1.2 (c).*

11.6 The penalty for contravening the road or railway crossing, or decontrol stop Regulation two (2) or more times during an event will be exclusion. *Refer ART 20.1.6 (f).*

12. PRE- AND POST-RACE

12.1 Pre-race line-up

12.1.1 The Pre-Race line-up for any competitive section will commence thirty (30) minutes prior to the start of the section. Crews must personally present their vehicle in the line-up, in good time, and a member of the crew must remain with the vehicle.

12.1.2 Any crew, or vehicle, not in the pre-race line-up in the sequence published on the start order, or not present at their published start time, will be started at the discretion of the Start Officials when it is safe to do so and when it does not inconvenience or disadvantage another crew.

12.1.3 Crews who arrive at the start line out of sequence, or late for their start time, will wait on arrival until instructed by the start officials to proceed. Any such crew's race time will be deemed to be the published start time and no time compensation will be given.

12.1.4 Reserved

12.2 GPS activation

12.2.1 GPS units must be powered up and operational prior to the crew's start time. Failure to power up and activate the GPS unit and reset the Data Logging Equipment will incur a five (5) minute penalty. *Refer ART 20.1.1 (f).*

12.3 Post-race paddock

12.3.1 The Organisers reserve the right to include a Post-Race Paddock at the finish of a competitive section into which all competition vehicles must be placed.

12.3.2 Release from the Post-Race Paddock will be at the discretion of the COC. *Refer GCR 252 (i) to (vii)* as applicable.

12.3.3 Only officials and competitors may enter the Post-Race Paddock. *Refer ART 20.1.6 (h).*

13. OUTSIDE ASSISTANCE | MEDICAL OR FIRE ASSISTANCE | SERVICE PERSONNEL

13.1 Outside assistance

13.1.1 The Regulations governing Outside Assistance commence at the start of a competitive section once the vehicle has joined the pre-race line-up.

13.1.2 Servicing and assistance is only permitted at the DSP/s, or at a point specifically permitted in the SR's, Final Instructions, Bulletin or Official Notice published by the COC.

13.1.3 Servicing of vehicles within the limits of a control area is prohibited. The vehicle must first be pushed out of the control area and may then be serviced. *Refer ART 8.3.1 & ART 20.1.6 (p).*

13.1.4 Competitors may repair their competition vehicle whilst on the route using the spares and equipment carried aboard their competition vehicle. Competitors may receive assistance from another competitor who is still competing. No assistance may be accepted from team members, service crew, relatives, friends, business associates, service crews of fellow competitors, etc. Competitors may not receive any manufactured materials, spare parts, tools, or equipment outside of the DSP/s. The establishment of "spares depots" adjacent to the route is strictly prohibited. Impromptu, outsider goodwill assistance may be accepted from landowners, officials, or spectators.

Any competition vehicle that has broken down on the route may NOT be repaired or recovered on the race route without written permission from the COC. *Refer ART 20.1.6 (p).*

13.1.5 The transfer of electronic data relating to the vehicle's operating systems to or from the competition vehicle by any means whatsoever is not permitted.

13.1.6 Competitors may receive assistance in servicing their vehicles from fellow competitors who are competing in the event. Competitors who have completed the event may not provide assistance.

13.1.7 A competition vehicle that is stuck on the route and that is blocking the route may be removed with outside assistance by any other vehicle but may not be towed for any distance other than to remove the vehicle to a safe position and clear the route.

13.2 Medical / Fire assistance

13.2.2 Notwithstanding the provisions of *ART 13.1* above in the event of an accident in which a member of a vehicle's crew requires medical assistance, such assistance may be given by a third party including another competing vehicle.

13.2.3 In the event that competitors encounter a fire whilst on the route they are to immediately stop and attempt to extinguish the fire and call the emergency number on the Road Book to advise officials of the fire.

13.2.4 The COC will be empowered to investigate instances where competitors have rendered medical or fire assistance and take appropriate action deemed necessary. Corrected time will only apply when assistance is rendered at a medical incident or fire.

13.3 Service personnel

13.3.1 Competitors' attention is drawn to *GCR 251* regarding the conduct of their service personnel and supporters.

13.3.2 Service personnel and supporters may not enter, traverse, or proceed onto the route of a competitive section without the express permission of the COC. *Refer ART 20.1.8.*

13.3.3 A competition vehicle that has broken down may not be recovered from the race route without the express permission of the COC, or until such time as the route has officially been closed by the COC. *Refer ART 20.1.8.*

14. PRE-RACE PRACTISING |

AERIAL OBSERVATION | USE OF DRONES

14.1 An entry from a competitor who is found to have practised over, or in the vicinity of the route, at any time during the sixty (60) days preceding the event will not be accepted. This, however, does not apply to legitimate participation in an event which may cross or use sections of the route within sixty (60) days preceding the event or to competitors involved in organising their Club's event in terms of ART 25.1 of these Regulations.

All decisions in this respect will be referred to the COC. Refer ART 20.1.6 (j).

14.2 Aerial observation of race vehicles from aircraft, including drones, and air to ground communication between observers and car competitors are strictly forbidden during races. Aerial photography may be allowed with the written permission from the COC subject to the prevailing laws and Civil Aviation Authority. Refer ART 20.1.6 (k).

14.3 Use of Drones

14.3.1 All Commercial drone operators require various SACAA-issued licenses. Private recreational use may not require an individual license but still demands adherence to SACAA safety and security guidelines.

14.3.2 Drones may not fly closer than fifty (50) meters from people or private property without written permission, and must avoid restricted airspace like airports/airfields

14.3.3 Persons operating drones at the event must obtain written permission from the COC, and file an electronic copy of their SACAA license, together with proof of the associated Public Liability Policy with the Secretary of the Meeting at entries.tiorcsa@gmail.com at least seven working days prior to the event.

14.3.4 The operator is requested to introduce her/himself to the official at the start line in advance of the start.

14.3.5 Drones at the start and finish of events will be strictly controlled and restricted to the Promoter and Organiser's appointed service provider/s only. A minimum flying height of three (3) metres above the start/finish line / arch and event start and finish area must be observed

14.3.6 All other drones are prohibited from use at the Line-up, the Start Arch, and the first hundred (100m) metres of the route and the DSP area.

15 YELLOW / WHITE LIGHTS

15.1 Organisers are required to have a **minimum of one (1) light check point** on the Racing Section of an event to ensure that the yellow and white lights on competition vehicles are operational.

15.2 **Failure to repair a yellow light** immediately after being instructed to do so by an official or marshal will incur a penalty of exclusion and the competitor will be prevented from racing any further. Refer ART 20.1.6 (l).

15.3 **Failure to repair a white light** immediately after being instructed to do so by an official or marshal whilst racing will incur a penalty of fifteen (15) minutes. Refer ART 20.1.3 (e).

16. START ORDER

16.1 Qualifying

16.1.1 The Championship maintains a seeding system used to determine Qualifying Starting Order for events forming part of the series. Competitors seeded in the top five (5) positions will draw for their start position.

16.1.2 Unseeded drivers will be allocated a starting position determined by the COC based on safety considerations.

16.2 Seeding system

16.2.1 The Series Seeding System is based on Qualifying Results only.

16.2.2 For each event, Qualifying Winner's Qualifying Elapsed Time is expressed as a percentage with the ideal (winning time) being 100%.

16.2.3 The Qualifying Elapsed Time for all drivers classified as finishers of the Qualifying in question are expressed as a percentage of the winning time.

16.2.4 A driver's best four (4) results are used to calculate an average percentage and drivers are then ranked from the driver with the highest percentage to the lowest.

16.2.5 The average for drivers who do not have four (4) or more Qualifying results is calculated taking all of their results into account.

17. UNSPORTSMANLIKE CONDUCT

17.1 Overtaking of fellow competitors in any motorsport competition is a given. Unsportsmanlike behaviour will not be tolerated and bumping and barging is prohibited.

17.2 Intentionally blocking a fellow competitor is prohibited. It is the duty of every competitor to recognise when another competitor has caught up to them and is trying to overtake and to allow them to do so at their earliest convenience and at the first safe opportunity to do so.

- 17.3 Unsportsmanlike conduct in the form of intentionally blocking and preventing overtaking, and/or bumping, and/or ramming a competitor must be reported to the COC on the Incident Report. The reporting competitor must accurately reflect the location and duration of the incident on the Incident Report. Road Book instruction number and/or accurate distance must be supplied. Vague information, or deliberate exaggeration will result in no action being taken. *Refer ART 20.1.6 (m).*
- 17.4 The COC may call for, and scrutinise, individual competitors' in-car camera footage as well as information from the GPS Tracking or Committee appointed Monitoring System/s to establish whether a transgression of the Rules is apparent. The onus is on the competitor concerned to provide clear evidence that they did not contravene the rule, failing which the COC will apply the specified penalty/penalties. *Refer ART 20.16 (m) & ART 20.2.5.*

18. REFUEL

- 18.1 Refuel points shall be a maximum of 175 kilometres apart.
- 18.2 18.2.1 Refuelling will take place at the DSP and any additional Refuel Points as may be published in the SRs / Final Instructions / Bulletin / Official Notice by the COC on the Electronic Notice Board.
- 18.2.2 Should the loop / race distance require remote refuel zones may be established.
- 18.3 Refuelling procedure**
- 18.3.1 No person may be seated in a competition vehicle during the refuelling process. Both Driver and Navigator must exit the vehicle before refuelling of the vehicle commences.
- 18.3.2 The vehicle's engine must be switched off and must remain switched off until the refuelling process has been completed.
- 18.3.3 Two (2) fire extinguishers shall be placed close at hand on either side of the vehicle during refuelling and are to be manned by the competitors' or service personnel.
- 18.3.4 Each competitor's refuel area shall be equipped with two (2) handhelds Dry Chemical Powder (DCP) fire extinguishers with a minimum capacity of 4.5kg powder each. These extinguishers shall be certified for Class A, B and C fires and conform as a minimum to SABS 1910 for the bottle and SANS 1522 for the powder. Each handheld extinguisher must be equipped with a pressure gauge to check the pressure of the contents.
The following information must be visible on each fire extinguisher:

- a) Capacity
- b) Type of extinguishant
- c) Weight or volume of the extinguishant
- d) Date the extinguisher must be checked which must be no more than one (1) year after either date of filling or the date of the last check or the corresponding expiry date.

18.3.5 The use of environmental mats is compulsory at ALL refuel areas, including the Designated Service Points. *Refer ART 20.1.4 (b).*

18.3.6 The Organisers must appoint a Safety Officer who will observe the refuelling procedure and who must report any infringements of the refuelling Regulations observed to the COC for further action. The penalty is thirty (30) minutes. *Refer ART 20.1.4 (c).*

18.3.7 Empty fuel drums must be removed from the refuel area / DSP by the competitors or their service personnel. *Refer Appendix 3 - Fuel Storage & Safety: Article 1.2 of the MSA Environmental Code.* Failure to comply with this requirement will result in a fine as detailed in *ART 20.1.7 (b).*

18.4 Designated Refuel Zone

18.4.1 Refuelling of vehicles during the Racing Section will only be permitted within the confines of the Designated Refuel Zone during competition. No vehicle may be refuelled in the DSP area at any time during the running of the Qualifying or the Racing Section.

18.4.2 Any competitor who needs to refuel at the end of a loop or lap must do so within the confines of the Designated Refuel Zone.

18.4.3 The Competitor's crew will be responsible for placing an environmental mat and the required fire extinguishers in the Designated Refuel Zone.

18.4.4 The provisions of *ART 18.3 and 21.6* will apply within the DSP and within the Designated Refuel Zone.

18.4.5 The Competitor's service crew are permitted to pass the crew water or drinks whilst in the Designated Refuel Zone and to carry out routine tasks such as cleaning windscreens or visors. No mechanical repairs or service may be carried out whilst the vehicle is in the Designated Refuel Zone. Should mechanical repairs be required the crew must first complete the refuelling procedure and then proceed into the DSP to carry out repairs.

19. ACCIDENTS | MEDICAL WARNING BOARDS | INCIDENTS | RETIREMENTS | MISDEMEANOURS

19.1 Accidents

19.1.1 Should a competitor come across an accident / vehicle stopped on, or at the side of the route, where no medical warning board displaying the green "O" or "OK" is displayed it must be assumed that the injuries are of such a nature that the competitors concerned are seriously injured and unable to display their medical warning board. Assistance must be rendered immediately.

19.1.2 Refer to ART 19.2 for the correct procedure and use of the medical warning boards.

19.1.3 DO NOT move an injured person unless he / she is in a dangerous position. Inform the officials using the emergency number, as well as the next marshal, as soon as possible to summon assistance. Please supply the injured person's location (Google map pin / GPS location), Name (where possible) and Competition Number (where applicable).

19.1.4 When an ambulance is encountered on the route it has the right of way at all times.

19.1.5 Competitors who render assistance at an accident may be compensated for the time spent at the scene using the information from their GPS and/or Tracking Device and any other electronic information they are able to furnish. Should such electronic information not be available for whatever reason the time compensation will be calculated by taking the interval to another competitor most closely matched in speed at various controls. For example, if the competitors are running roughly the same speed as another competitor, it can reasonably be assumed that the time gap between them would have remained the same at the next control and the difference between the expected time and actual time be returned to them.

19.1.6 A competitor or crew involved in an accident where medical assistance is required and who is then unable to continue racing may not claim compensation.

19.2 Use of medical warning boards

19.2.1 Should any competitors stop due to mechanical or other failure and not require any assistance the green "O" or "OK" must be clearly displayed to oncoming vehicles until such time as the vehicle has been removed from the route. Competitors are reminded of the importance of displaying the OK board when their vehicle is stopped, and they do not require assistance to ensure that the status of the "stop" is clear to all concerned.

19.2.2 Should any competitors stop due to being involved in an accident whilst on the route being used for an event the two (2) medical warning boards together with a warning triangle must be displayed.

19.2.3 Should medical assistance be required the medical warning board must be displayed in such a manner that the red cross is clearly visible to oncoming competitors, preferably at eye-level. Care must be exercised to ensure that the correct side of the board is displayed to oncoming competitors. While the medical warning board is displayed in such a manner the first competitors arriving at the scene of an accident must stop and render assistance. Should this not be possible the competitor must display the distress sign by holding both hands in triangular shape above your head and jump up and down to attract on-coming competitors' attention.

19.2.4 A second Medical "Board" which will be of a cloth type of material with eyelets in each corner must be carried in the vehicle. This should be attached to the top of the stationary vehicle so that it is visible from overhead. This is to assist with possible aerial evacuation or assistance.

19.2.5 Should additional assistance from additional competitors be required the competitors of the vehicle rendering the initial assistance must display their warning board with the red cross clearly visible to oncoming competitors.

19.2.6 Should no further assistance be required the green "O" or "OK" should be displayed. Once the injured competitors have been assisted their medical warning board should be displayed with the green "O" or "OK" clearly visible to oncoming competitors until such time as the vehicle has been removed from the route.

19.2.7 Misuse of the medical warning board will be treated as a serious offence and dealt with accordingly.

19.3 Incidents

19.3.1 Competitors will receive a link to an Online Incident Report at the start of an event. Any competitor who fails to submit an Incident Report within one (1) hour of finishing, or within one (1) hour of retiring from the event will be penalised in accordance with ART 20.1.7 (d).

19.3.2 Any incidents involving any person or property must be reported on the Incident Report. In particular, competitors must notify the organisers of any damage / broken fences or gates / crops so that the necessary repairs may be carried out timeously. Should a competitor fail to report any incident of this nature and such incident come to the attention of the Organisers a fine of Two Thousand Rand (R2 000.00) will be imposed by the COC. Refer ART 20.1.8 (b).

19.4 Retirements

19.4.1 Any competitor retiring from the event should notify Race Control of this as soon as possible by:

- a) Contacting the Secretary of the Meeting by telephone, WhatsApp, or SMS
- b) Completing the Online Incident Report noting that they have retired.
- c) Advising the nearest Marshal / Radio Marshal / Official and requesting they relay this to Race Control.

19.4.2 The information to be reported is as follows:

- a) Competition Number
- b) Reason for retirement
- c) Require assistance to return to DSP or not?

19.4.3 Should the competitor be unable to return to DSP before the end of the racing section the onus is on the competitor to request a team member to report this to the race officials.

19.4.4 In the case of competition vehicles with two crew members. Should one member of the competition vehicle's crew not be in the vehicle whilst racing the crew will be deemed to have retired from the event. Refer Art 2.3.4

19.5 Misdemeanours

19.5.1 Penalties for misdemeanours or transgressions of the Rules discovered during or after an event entailing damage to property, but not limited to, may be applied after the event. Refer ART 20.1.3 (g) & ART 20.1.4 (d).

20. PENALTIES

20.1 The following penalties will be imposed by the COC and where such penalties are applied it shall not be necessary to hold a hearing with competitors in terms of GCR 175.

20.1.1 Five (5) minutes

- a) Contravening the traffic flow direction or smoking in the DSP. Refer ART 5.2.
- b) Non-attendance at the Competitors' Briefing. The penalty will be applied per competitor that fails to attend the Competitors' Briefing. ART 2.9.2.
- c) Minor deviation from the route. Time

advantage gained to be added to the penalty. ART 7.3.1.

- d) Contravening ART 8.4.6 (d) exceeding the demarcated speed limit. Five (5) minute penalty for exceeding the speed limit. No exceptions above that. The COC may impose stricter penalties in the case of repeat offences.
- e) Failure to report timeously at a decontrol official which may include DSP controls. ART 10.1.2 (d).
- f) Failure to activate and reset the GPS unit. ART 12.2 (a)
- g) Cutting corners marked with corner markers indicating the inside and/or outside of the corner. Penalty for flattening the marker, taking the marker out, passing on the inside/outside of the marker. Five (5) minute penalty for each marker. The COC may increase the penalty for more than three incidences. ART 7.5
- h) The penalty for exceeding the averaged speed limit is five (5) minutes for every transgression. The COC may impose stricter penalties in the case of repeat offences. ART 5.4

20.1.2 Ten (10) minutes

- a) Early departure from any start controls during the event. ART 8.2.3
- b) Failure to stop at a Light Check Control or ignoring a light check control official's instruction. ART 8.4.5 (g).
- c) Not stopping as per ART 11.3 & ART 11.5.

20.1.3 Fifteen (15) minutes

- a) Contravention of ART 3.5 pertaining to Medical Board and Warning Triangle.
- b) Major deviation from the route. Time advantage will be added to the penalty. ART 7.3.2.
- c) Contravention of ART 8.3.2 pertaining to the procedure at Timing Controls.
- d) Contravention National and / or Local Traffic Regulations. ART 8.4.7 (b).
- e) For being unable to repair a white light when instructed to do so by a Light Check Marshal or any other official. ART 8.4.5 (g) & 15.3.
- f) Failure to allow overtaking and/or intentionally blocking those trying to overtake. ART 17.2 & 17.3
- g) First offence for a misdemeanour or transgression. ART 19.5.1.

20.1.4 Thirty (30) minutes

- a) For interfering with, turning off or otherwise preventing timing, tracking, or monitoring devices from performing as designed.
- b) Failure to use an environmental mat in the DSP area. *ART 18.3.5.*
- c) Contravention of the refuelling procedures and Regulations. *ART 18.3.6.*
- d) Second offence for misdemeanour or transgression. *ART 19.5.1.*

20.1.5 Sixty (60) minutes

- a) Failure to complete the documentation and/or scrutineering formalities by the closing times stipulated in the SRs / Final Instructions / Bulletin.
- b) Missing a control or failing to stop at a control or ignoring a control official's instruction. *ART 8.2.4.*
- c) For overtaking in a speed control section. *ART 8.4.6 (e).*

20.1.6 Exclusion

- a) Failure to carry out the instruction of an official.
- b) Failure to wear a crash helmet and/or neck restraint / foam neck brace while racing and non-compliance with the crash helmet requirements and/or neck restraint requirements and/or for failure to have the safety harness properly fastened at all times whilst in a moving vehicle. *ART 2.5.1 & ART 2.5.2.*
- c) Failure to have the GPS and/or tracking device fitted as stipulated and operational. *ART 2.8 & ART 2.9.*
- d) Finishing an event with a different chassis or engine block number to that fitted to the vehicle when scrutineering and/or recorded on the self-scrutineering form. *ART 3.6*
- e) Failure to obey the Route Direction and Route Deviation Regulations. *ART 7.1 & ART 8.3.3.*
- f) Contravention of the Road and Rail Crossing and Decontrol Regulation two (2) or more times. *ART 11.6*
- g) Failure to place a vehicle in a Post-Race Paddock on completion of the event. *ART 12.3.1*
- h) Entry into the Post-Race Paddock by a competitor or his service personnel without the COC's permission except when placing the vehicle in moving the vehicle out of the post-race paddock. *ART 12.3.3.*

- i) For being towed or pushed other than to clear the vehicle causing an obstruction. *ART 13.1.7.*
- j) For having been found to have practiced on, or in the vicinity of the route within sixty (60) days preceding the event. *ART 14.1*
- k) For aerial observation of race vehicles from aircraft, including drones, and / or air to ground communication between observers and competitors whilst racing. *ART 14.2*
- l) For failure to repair a yellow rear light. *ART 15.2*
- m) For bumping or ramming a competitor. *ART 17.3 & ART 17.4*
- n) For carrying fuel in loose containers in a competition vehicle. Refer *PART III - Technical Regulations and Specifications*
- o) For failing to comply with the provisions of *ART 19.1 & 19.2*
- p) For receiving outside assistance other than from a competitor still competing. *ART 13.1.4 & 10.2.*
- q) Failure to have a screamer unit fitted to the vehicle or failure to repair a screamer unit when instructed to do so by an official. *ART 2.10.*

20.1.7 One thousand rand (R1 000.00) fine

- a) Failure to present the GPS Unit for download at the end of a Racing Section or heat. *ART 2.8.4*
- b) Failure to remove empty fuel containers. *ART 18.3.7.*
- c) Failure to display the "O" / "OK" board when stopped due to mechanical or other failure. *ART 19.2.1.*
- d) Failure to submit an Incident Report within one (1) hour of completion of, or retirement from a Racing Section or Heat. *ART 19.3.1.*

20.1.8 Two thousand rand (R2 000.00) fine

- a) For receiving assistance in recovering a vehicle from the route during the running of the event without the express permission of the COC. *ART 13.3.2. & 13.3.3.*
- b) Failure to report any damage to property or injury to persons to the Organisers on the completed Incident Report. *ART 19.3.2.*
- c) Failure to preserve GPS tracklog data for a period of seven (7) days after the event. Refer *ART 2.8.10.*
- d) Activating the SOS button incorporated into the tracking unit for any reason other than to summon emergency medical assistance in the event of an accident. Refer *ART 2.9 (a).*

20.2 Penalties that may be imposed by the COC in respect of a contravention of any of the items listed below, subject to a hearing being held in terms of GCR 175.

20.2.1 For smoking whilst racing.

20.2.2 For driving dangerously or without due consideration for other road users.

20.2.3 For allowing a person not in possession of a valid driver's licence / valid competition licence to be in control of a vehicle during a competition.

20.2.4 For carrying any unregistered passengers other than stranded competitors or officials.

20.2.5 For failing to afford the opportunity to overtake or deliberately preventing overtaking.

20.2.6 For contravening any Traffic Rules or Regulations.

20.3 Penalties that may be imposed by the COC in terms of GCR 157.

20.3.1 For behaving in a manner prejudicial to motorsport, bearing in mind that competitors are responsible for the actions of their service personnel and supporters.

20.3.2 Committing any breach of the GCRs, SSRs, these Regulations, the SRs, or Final Instructions for which no specific penalty is been stipulated.

PART II – CHAMPIONSHIPS

- ART**
- 21. ELIGIBILITY OF COMPETITORS**
- 21.1 Refer to *ART 2* of these Regulations.
- 22. CATEGORIES AND CLASSES**
- 22.1 To declare the following 2026 MSA Northern Regions Off-Road Car Racing Champions in the following categories:**
- 22.1.1 Special Vehicle Category Champion Driver and Navigator
- 22.1.2 Production Vehicle Category Champion Driver and Navigator
- 22.1.3 Lightweight Vehicle Category Champion Driver and Navigator
- 22.1.4 FIA Vehicle Category Champion Driver and Navigator.
- 22.2 To declare the following 2026 MSA Northern Regions Off-Road Car Racing Class Champions:**
- 22.2.1 Special Vehicle Category Classes – Winning Drivers and Navigators in Classes A, P, & B
- 22.2.2 Production Vehicle Category Classes – Winning Drivers and Navigators in Classes T/S, D & E
- 22.2.3 FIA Vehicle Category Classes – Winning Drivers and Navigators in the Big Wheel and Small Wheel Classes
- 22.3** For purposes of the MSA Northern Regions Off-Road Car Racing Championship, **Classic Off-Road Vehicles**, first raced in South Africa prior to the year 1999 will run as a Club, non-Championship, Class.
- 23. 2026 CHAMPIONSHIP SERIES**
- 23.1 The 2026 Championship events are as listed in the MSA Calendar, or as amended by MSA Circular.
- 23.2 Should fewer than four (4) events be run or scored, the MSA Northern Regions Motorsport Committee reserves the right to withhold the declaration of Champions.
- 24. POINTS SCORING**
- 24.1 A competitor's position within his Category and Class, together with his starting points will be used to determine Category Winners, i.e., Category Points + Class Points + Start Points.
- 24.2 A competitor's position within his Class, together with his starting points, will be used to determine the Class Winners, i.e., Class Points + Start Points.
- 24.3 No points will be awarded to a competitor who is excluded from an event.
- 24.4 Five (5) Start points will be awarded to each competitor who starts an event.
- 24.5 Category and Class points will be awarded on the following scale.
- | Position | Category Points | Class Points |
|------------------|-----------------|--------------|
| 1 st | 15 | 20 |
| 2 nd | 14 | 16 |
| 3 rd | 13 | 13 |
| 4 th | 12 | 12 |
| 5 th | 11 | 11 |
| 6 ^t | 10 | 10 |
| 7 th | 9 | 9 |
| 8 th | 8 | 8 |
| 9 th | 7 | 7 |
| 10 th | 6 | 6 |
| 11 th | 5 | 5 |
| 12 th | 4 | 4 |
| 13 th | 3 | 3 |
| 14 th | 2 | 2 |
| 15 th | 1 | 1 |
- 25. COMPETITORS INVOLVED IN ORGANISING THEIR CLUB'S EVENT**
- 25.1 Should a competitor be involved in the development, laying out or working of a route for a Regional Championship event the competitor may enter the event provided he was not involved in physically marking more than one third of the route.
- 26. MINIMUM NUMBER OF STARTERS**
- 26.1 An average of six (6) competitors per Category or Class must start an event for the relevant Category or Class to be awarded Championship Status for the season.

27. EVENTS TO COUNT

- 27.1 There will be seven (7) events with eight (8) scoring rounds of the Championship with the marathon event scored as two (2) events.
- 27.2 All events run will count towards a competitor's final score.

28. AWARDS

- 28.1 Year-End series awards will be allocated to competitors placed first, second and third in the Special Vehicle Category, Production Vehicle Category, Lightweight Vehicle Category and FIA Category provided that *ART 26.1* is met.

28.2 Year-end series awards will be allocated to competitors placed first, second and third in all Regional Classes, i.e., Classes A, P, B, T/S, D, E, F, G and FIA Big Wheel and Small Wheel provided *ART 26.1* is met.

28.3 In order to qualify for any awards the competitor/s concerned must have started at fifty per cent (50%) plus one (1) round of the events run.

28.4 Should the minimum requirements for the declaration of Champions not be met only series Class awards will be made.

29. SEPARATION OF TIES

29.1 In the event that two (2) or more competitors are tied on points at the end of a season the competitor with the greatest number of first places will be declared the Winner.

29.2 Should this not resolve the tie, the competitor with the greatest number of second places will be declared the Winner, failing which third positions and so on.

29.3 Should this still prove ineffective the MSA Northern Regions Motorsport Committee will declare the Winner on such basis as it deems fit.

PART III – TECHNICAL REGULATIONS AND SPECIFICATIONS

31. GENERAL REQUIREMENTS

- 31.1 *Part III* contains all the Technical Requirements for MSA Northern Regions Off-Road Car Racing in the Special Vehicle, Production Vehicle, Lightweight Vehicle, FIA based Categories and Classic Vehicle Club Class.
- 31.2 Safety will always be a top priority for the Controllers, and unsafe vehicles, at the sole discretion of an appointed Chief Scrutineer or Technical Consultant (TC) / Scrutineer will not be allowed to compete.
- 31.3 These Regulations are written in terms of authorisation, therefore, what is not expressly authorised hereinafter is not allowed.
All modifications not permitted by these Regulations are expressly forbidden.
- 31.4 Before manufacturing the first unit of a new vehicle series, the manufacturer must receive the agreement in principle from the Controllers by submitting a specification and drawing of the proposed vehicle, including the Safety Cage. The Controllers reserve the right to accept or refuse the Homologation or Certification of a vehicle and Safety Cage, in accordance with the design prescriptions established by MSA and the FIA. If there are any deviations from these, the MSA Regulations which have been agreed to for a specific vehicle, it must be clearly documented and signed by the Controllers, or their designated representative. The deviations must also be documented in the Vehicle Technical Passport.
- 31.5 In the case of Category Production Vehicles, the Manufacturer must elect a model of a vehicle in the production range on which the competition vehicle will be based. The details of the model of vehicle will be entered in the Vehicle Technical Passport.
- 31.5.1 Model of vehicle:
Vehicles belonging to a production-series distinguishable by a specific concept and external general lines of the bodywork and by an identical mechanical construction of the engine and the transmission to the wheels, with the same wheelbase and the same cubic capacity. To qualify as a model, the vehicle should have been sold in mass production quantities in one year in commercial dealer outlets in South Africa.
- 31.5.2 In the case of Category Special, Side by Side and FIA Vehicles, the model of vehicle is not applicable.
- 31.6 Production Vehicles built before 1 December 2010 must comply with the 2010 MSA Regulations.
- 31.7 Manufacturers intending to build vehicles for FIA controlled events must read the applicable FIA Regulations, as all the requirements are not included in these Regulations.
- 31.8 A vehicle of a lower Class may be permitted to enter and compete in a higher Class provided it complies with the lower Class's Rules. Permission must be requested from the Committee prior to the event.
- 31.9 "Committee Approved" (C.A.) shall mean:
Specific components shall be submitted to the Controllers for approval. The cost and specification of these components, if accepted, shall be communicated to all competitors and the components shall be freely available at a fixed price to any competitor for a minimum period of twelve (12) months subject to exchange rate fluctuation only. Only components referred to in these Regulations as "Committee Approved" shall be subject to the approval system. The supplier's details and component specification will be available from the Controllers.
- 31.10 A Category Special Vehicle is defined as a space frame tubular chassis vehicle with 4X2 transmission.
- 31.11 Deviations:
Should a specific car not be able to comply with a Regulation as published for a technical reason, the entrant may apply for a deviation to the rule, based on sound technical grounds. The application will be considered by the Committee, and if approved will be published as a deviation for all cars of the make/model. The Committee's decision will be final.
- 31.12 Dispensations:
Should a specific car not be able to comply with the Regulations as published for a temporary technical reason, such as parts unavailability, temporary crash repairs, etc., the entrant may apply for a dispensation, based on sound technical grounds.

The application will be considered by the Series Scrutineer in consultation with the Controllers, and if approved, will be published as a dispensation for a specific car for one or more events, but dispensations are limited to one year maximum. The Committee's decision will be final.

32. DEFINITIONS.

32.1 Group N engine

An engine produced and sold in quantities exceeding 2500 in one year and complying with *FIA Appendix J Art. 254* i.e., in the as manufactured condition, with no modifications to its internal components. To be accepted as such, an engine must be certified and sealed by an MSA appointed inspector before installation. It may be required to strip an engine for inspection.

32.2 Modified engine

All other non-certified engines used in the Championship.

32.3 A re-engined vehicle

A production vehicle fitted with an engine not manufactured by the manufacturer of the body and chassis of the vehicle.

32.4 Intake manifold

32.4.1 Petrol engines: Part collecting the combustion air and extending from the mounting face on the inlet ports of the cylinder head to the throttle valve plate.

32.4.2 Diesel engines: Part collecting the combustion air and extending from the mounting face on the inlet ports of the cylinder head to the first junction with the air ducting from the air filter for NA engines or the first junction with the air ducting from the charge air cooler for turbo engines.

32.5 McPherson suspension

Any suspension system in which a telescopic strut, not necessarily providing the springing and/or damping action, but incorporating the stub axle, is anchored on the body or chassis through a single attachment point at its top end and is pivoted at its bottom end either on a transversal wishbone locating it transversally and longitudinally, or on a single transversal link and located longitudinally by an anti-roll bar, trailing arm or compression rod.

32.6 Suspension travel measurement

The method for measuring the suspension travel is the following:

32.6.1 The vehicle must be level on stands on a hard, flat, level surface with the springs and dampers removed.

32.6.2 For independent suspension:

Where the bump and droop stops are mounted separately from the dampers, the external energy absorbers i.e., rubber stops, springs, hydraulic stops, droop straps, etc. must be removed.

- Solid dummy spacers may be mounted to take the place of solid parts in the energy absorbers to simulate the correct travel.
- Where telescopic dampers fulfil the task of bump and droop stops the dampers must remain fitted, but energy absorbers i.e., rubber stops, springs, hydraulic stops, etc. must be removed, including internal ones.
- Solid dummy spacers may be mounted to take the place of solid parts in the energy absorbers to simulate the correct travel.
- The measured wheel travel is the vertical displacement of the wheel centre when displaced between the upper bump stop and lower droop stop.

32.6.3 For suspension with rigid axles:

The vehicle must be level on stands on a hard, flat, level, surface with the springs and dampers removed.

- Where the bump and droop stops are mounted separately from the dampers, all energy absorbers i.e., rubber stops, springs, hydraulic stops, etc. must be removed. Where droop straps are used as standard, the standard droop straps must be retained. Solid dummy spacers may be mounted to take the place of solid parts in the energy absorbers, including droop stops, to simulate the correct travel.
- Where telescopic dampers fulfil the task of bump and droop stops the dampers must remain fitted, but energy absorbers i.e., rubber stops, springs, hydraulic stops, etc. must be removed, including internal ones.
- Solid dummy spacers may be mounted to take the place of solid parts in the energy absorbers to simulate the correct travel.
- Where leaf springs are mounted to locate the axle as well as provide the spring medium, the leaf springs must remain fitted. The damper or droop strap without energy devices also remain fitted. The distance with axle hanging at full droop to solid portion of bump stop must be measured on left and

right sides.

- The measured wheel travel is the simultaneous vertical measurement of the left and right wheel centres between the upper bump stops and lower droop stops. Both the left- and right-hand measurements must be within specification.

32.7 Bump and droop stops

Bump and droop stops are defined as solid, elastic and/or hydraulic buffers, stopping/damping the suspension at the end of its travel upward and downward. Bump and droop stops do not form an active part of the suspension except at the end of the travel upwards and downwards.

32.8 Anti-tramp rods

Anti-tramp rods on rigid axles shall comprise a single central longitudinal rod or one longitudinal rod per side, which prevents leaf spring twist under acceleration and braking. The rods shall be one piece, shall offer no lateral support to the axle, and shall make an angle of less than 10° with the longitudinal axis of the vehicle.

32.9 Technical Passport

A document issued by the Controllers which must accompany each competing vehicle to each event it competes in. This document identifies the vehicle and contains all the technical details including deviations and upgrades for the specific car. The onus is on the competitor to update the technical details in the document. The document may be updated on-line or at scrutineering and stamped by the TC / Chief Scrutineer. Failure to produce this document on request may result in a penalty imposed at the discretion of the COC. The reference to the date of the passport must be understood as the date on which the technical passport was first issued. The Technical Passport contains the history of the vehicle and remains with the vehicle when sold.

32.10 Fuel for all Classes, FIA included

32.10.1 As per GCR 240. Only 93 or 95 octane commercially available pump petrol may be used.

- Only commercially available pump diesel may be used.
- No additives allowed in the fuel.
- An appointed TC / Chief Scrutineer may collect fuel samples for analysis if required.

32.10.2 Dispensation is granted for the FIA Vehicle Category to increase the octane of the fuel used

to a maximum of 102.6 RON with lead content not exceeding 0.013 gPb/l. Refer GCR 240.

33 PERFORMANCE CONTROLS

33.1 Minimum weights

- All cars are subject to the following scale of minimum weights in relation to cylinder capacity, unless otherwise specified in the individual Class technical specifications.
- For forced induction engines, the nominal cylinder capacity is multiplied by 1,7 and the car must pass into the Class corresponding to the fictive volume thus obtained. The car must be treated in all respects as if its cylinder capacity thus increased were its real capacity. This is particularly the case for assigning the car to its cylinder capacity Class.

Note: Production vehicles in Class S will comply to the 2014 Regulation, which is 60 kg higher than the table below. *Refer ART 52.1.2.*

- This is the weight of the car without fuel, with spare wheel/s as fitted at all times during the event. All Production Vehicles shall carry and be weighed with two spare wheels of the size fitted on the car. All Special Vehicles shall be weighed with one spare wheel of the size/s fitted on the car. The engine cooling fluid and lubricants, as well as the brake fluid must be at normal levels.
- The other tanks for consumable liquids must be drained and the following elements must be removed from the car:
 - Occupants, their equipment, and luggage.
 - Tools, portable jack, and spare parts.
 - Survival equipment.

Cylinder Capacity in cc.	Weight in kg (4X4)	Weight in kg (4X2)
Up to 1600	1090	800
Over 1600 and up to 2000	1290	920
Over 2000 and up to 2250	1440	950
Over 2250 and up to 2500	1540	980
Over 2500 and up to 2750	1577.5	1010
Over 2750 and up to 3000	1615	1040
Over 3000 and up to 3250	1652.5	1070
Over 3250 and up to 3500	1690	1100
Over 3500 and up to 3750	1727.5	1130
Over 3750 and up to 4000	1765	1160
	(1825 Class S)	
Over 4000 and up to 4250	1802.5	1190
Over 4250 and up to 4500	1840	1220
Over 4500 and up to 4750	1877.5	1250
Over 4750 and up to 5000	1915	1280
Over 5000 and up to 5250	1952.5	1310
Over 5250	1990	1340

33.1.1 Provisions.

- For weighing purposes, obvious lost components may be added at the discretion of the COC, and heavy mud and sand may be required to be cleaned before weighing.
- The weight of the car may be completed by adding one or several ballast weights, provided they are strong and unitary blocks, fixed by means of tools, capable of having seals affixed and of being placed on the floor of the cockpit, visible and sealed by the TC / Chief Scrutineer.

33.2 Power output restrictions

33.2.1 The Controllers reserve the right to restrict the power output of any competing vehicle to balance the performance in a Class.

33.2.2 All competing vehicles in the Championship, with the exception of Class B and Class E petrol, will be fitted with induction air restrictors. The preferred method of engine power reduction will be the use of an induction air restrictor of a size and shape specified by the controllers, suitable to reduce the power output of any competitor's engine in the interest of performance equalisation. The figures listed below in 33.2.8 are the maximum diameter, in mm, that restrictors may be for each application listed and must be in compliance when measured at any temperature. The axial length of this restrictor diameter must be 3mm, minimum.

33.2.3 On all engines, all induction air (air received by the engine in order to support the combustion of fuel) must pass through the restrictor.

33.2.4 In the case of forced induction engines, the exit of the inlet air restrictor (3mm parallel portion) must be within 50mm of the extremities of the turbo compressor impeller blades on the inlet side. The internal volume of the induction pipe between the outlet of the restrictor (turbo side of the 3mm parallel portion) and the throttle body valve may not exceed 10 litres.

33.2.5 The controllers reserve the right to conduct a "stall test" on all relevant competing vehicles at any time during an event. The "stall test" involves inserting a machined plug of the specified diameter (see 33.2.8/9/10) into the restrictor, at which point the engine must stall (cease to run).

Any engine, subjected to the test that continues to run, will be deemed to have additional air being supplied, and therefore has a system that

is non-compliant.

33.2.6 Penalties for non-compliance with technical Regulations are detailed in *GCR 176* in the MSA Handbook.

33.3.7 Provision for the sealing of the restrictor must be provided.

33.2.8 Restrictors

33.2.9 Class D & E refer to Class specific restrictor requirements.

33.2.10 Modified diesel engines are not allowed.

33.2.11 Restrictor sizes

ENGINE TYPE	DESCRIPTION	RESTRICTOR SIZE (ID mm)
-------------	-------------	-------------------------

i) FIA classes See Class Regulations

ii) Petrol engines Gp N: 37

Gp N V8 rocker arm engines 39 over 5400cc, 4X2, Class A

Ford, Nissan & Toyota, 4000cc 39 max, Class S, minimum weight exceeding 1900kg

Ford, Nissan & Toyota, 4000cc 37 max, Class S: minimum weight exceeding 1825kg

Class P, engines Gp N, 4300cc No Restrictor max

34. EXHAUST SYSTEMS

34.1 All vehicles must be fitted with steel exhaust systems that exit to the back and/or face upwards from the horizontal. Vehicles with side exit exhausts will be acceptable providing the exhaust is made to exit upwards. Downward facing exhausts are not acceptable.

34.2 To prevent fires starting as a result of a vehicle coming to rest in dry grass or undergrowth, exhaust systems that run under vehicles must be protected by a heat shield or be wrapped with insulating material. The appointed Chief Scrutineer / TC will inspect exhausts for fire compliance. If necessary, repairs will have been made and approved by the appointed Chief Scrutineer / TC before the vehicle is permitted to start the event.

34.3 Competitors are to ensure that the engine management systems are set to cut fuel on overrun, including the sequential gear flat shift, to eliminate exhaust flame-spitting under all racing conditions.

A race vehicle seen with flames out the exhaust at any time may be suitably penalised up to immediate exclusion. Refer ART 20.3.2 and GCR 157.

35. WINDOWS, SAFETY NETS, MIRRORS, CUTTERS

- 35.1 **Side doors or side openings without windows** for the crew must have the window area covered by adequately secured safety nets. It is mandatory that all safety nets are attached to the roll cage of the competition vehicle with sturdy quick release buckles to allow quick emergency exits. The upper side of the net must be permanently fixed to the structure, and not removable without tools. The safety net must cover the side area between the steering wheel and the back of the seat, and from the roof to below the elbow.
- 35.2 The **safety net** must be made of sturdy webbing straps with minimum strap width 15mm and maximum strap width 25mm professionally sewn together in square blocks. The square block aperture must be more than 40mm per side and less than 80mm per side to allow side visibility to the crew but also protect the hands and arms flying about in an accident. Shade net, fishnet, etc., not allowed.
- 35.3 **Polycarbonate Side Windows:** windows must be to specification Lexan F2000 Sheet or equivalent, minimum thickness 3mm. It must be possible to remove the windows from inside the car without tools very quickly. The size of the opening in a side window may not exceed 175 x 175 mm.
- 35.4 All vehicles must carry a **Life Hammer** and/or blade knife which will be attached by means of Velcro on an orange background in a position accessible to the Driver and Navigator (normally seated with safety harness fastened), and to officials.
- 35.5 **Rear View Mirrors:** All competing vehicles must be fitted with either, a rear-view mirror (central and within the passenger compartment) or two rear view mirrors (one each side of the vehicle on the outside of the passenger compartment) or both. The minimum size of the single inside mirror is 144cm squared, and of the two outside mirrors are 60cm squared each. All mirrors must be able to see vehicles following, be in good condition and, in the case of the outside mirrors, have good protection.

36. FIRE EXTINGUISHERS

- 36.1 All vehicles must be fitted with a **minimum of two handheld fire extinguishers.**
- 36.1.1 One handheld extinguisher is to be fitted in the crew compartment in a place accessible to the driver and/or navigator.
- 36.1.2 The second handheld extinguisher is to be mounted externally on the vehicle in an accessible position, as best as possible protected against tree branches, flying stones and direct sunlight, and as far away as possible from the fuel tanks, oil tanks and engine of the vehicle.
- 36.1.3 The handheld extinguishers must be secured by a minimum of two (2) screw-locked metallic straps and the securing system must be able to withstand a deceleration of 25g. Only quick-release metal fastenings with metal straps will be accepted.
- 36.1.4 The handheld fire extinguishers shall comply with SABS 1910 for the extinguisher cylinder with a minimum capacity of 2,5kg DCP extinguishant. The extinguishant shall be mono-ammonia-phosphate (MAP), containing a minimum of 70% MAP in the DCP (Note the 70% is higher than the industry standard 40%). The DCP shall comply with SANS 1522.
- 36.1.5 Alternatively the 2.4 litre AFFF foam types as listed by FIA may also be used.
- Note*, two handhelds are required as stated above, not one as per FIA. One (1) dry powder and one (1) AFFF foam handheld extinguisher may be used as a pair. In this case the AFFF should be fitted in the crew compartment, as it is easier to breathe when used in a confined space the following information must be visible on each handheld extinguisher:
- type of extinguishant
 - weight or volume of the extinguishant
 - date the extinguisher must be checked, which must be no more than one (1) year after either the date of filling.
 - or the date of the last check, or corresponding expiry date.
- 36.1.6 each handheld extinguisher must be equipped with a pressure gauge to check the pressure of the contents.
- 36.1.7 Mounted piped systems to *FIA Standard 8865-2015 (Technical List n°52)* are recommended but will be regarded as additional to that specified above.

- NOTES: a) Handheld fire extinguishers in vehicles should ideally be taken out every six (6) months, as the extinguishant
- can compact with road vibration. Turn upside down to loosen the powder and replace.
- b) Anti-freeze in the cooling system should be no more than 50%. The rest should be water to minimise fire risk of ethylene glycol.

37. FUEL TANKS

- 37.1 Fuel must be carried in metal/moulded plastic tanks of acceptable quality and safety standards, or FIA approved fuel cells which are within their expiry period. The original expiry period may be extended after inspection by the appointed Chief Scrutineer / TC upon request of the competitor and recorded in the Technical Passport. Metal/moulded plastic tanks must be Committee Approved and recorded in the Technical Passport with a serial number. The minimum wall thickness of moulded plastic tanks must be 6mm. The material should be resistant to degradation by all automotive fuels, i.e., petrol, diesel, alcohols, and additives as well as to flame propagation. The material should have a measure of U-V resistance, not be susceptible to static charge loading, and have sufficient toughness to withstand off-road racing damage. The use of safety foam in tanks is recommended.
- 37.2 Tanks must be efficiently protected and very firmly attached to the body shell or the chassis of the car. Ideally all non-metal tanks should be carried in metal holders, at least the size and shape of the bottom half of the tank, to carry the full fuel weight and to protect the tank against external damage.
- 37.3 All tanks must be secured to the frame or chassis by at least two straps which are at least 50mm wide and minimum 1.5mm thick for steel. Straps to be separated from the tank by a non-metallic strip to prevent abrasion. In all cases, the tank including the filling pipes, must be totally insulated by means of flameproof and liquid-tight bulkheads or casings, preventing the infiltration of fuel into the cockpit or contact with the exhaust pipes. No part of a fuel tank system may be fitted or protrude outside of the chassis/safety cage of the vehicle.
- 37.4 All vehicles must have fuel lines which are secured and in good condition. The breather pipe must be fitted with a gravity activated roll-over valve and routed up, across, and down

below the fuel tank bottom, so that no matter which way a vehicle is rolled, a portion of the breather pipe will be higher than the tank, thus preventing fuel spillage.

- 37.5 No fuel may be carried in loose containers. *Refer ART 20.1.6 (n).*

38. BATTERIES, LIGHTING, ELECTRICAL

- 38.1 The battery/ies must be securely fitted. No more than two (2) batteries allowed. The batteries must be fitted inside the safety cage/chassis. Batteries must be covered against damage and short circuits. Acid type batteries fitted in the passenger cabin must be contained in a leak proof box.
- 38.2 All vehicles must have two (2) battery isolator switches fitted in obvious positions, clearly marked inside and outside the car where it is accessible to the Driver and Navigator and external rescue personnel. This switch must be wired so that the engine and all electrical ancillaries' cuts out when it is operated.
- 38.3 All vehicles must have ignition coils mounted away from fuel lines and fuel pumps.
- 38.4 White lights: All vehicles must have at least one (1) white light of 55-watt (550 Lumen) intensity minimum, visible from the front of the vehicle, fitted and operational throughout the event, to enable the vehicle to be visible to other competitors being approached. *Refer ART 38.* This white light may be the production vehicle's own head or driving light/s and must be protected by a cage to prevent it from being displaced. Special Vehicles must have these lights mounted as high as possible, preferably just under roof height, and preferably two (2) lights, one (1) at either side just inside the A-pillar.
- 38.5 Yellow lights: For safety reasons yellow lights are required to be fitted at the rear of all vehicles and be operational for the duration of the event. This provides more visibility in dust during close racing. The lights must be activated by the main battery isolator switch only and have no other auxiliary isolator switch. The lights must be fitted within 500mm of the vertical centreline of the vehicle and within 300mm of the highest point of the vehicle. *Refer ART 38.* The lights must be placed so that it can be seen from ground level 15 metres from the rear of the vehicle. The following lights define the minimum specification for rear mounted yellow.

3.8.5.1 VISIONX Solo Pod LED light series:

- a) Prime model, item no XIL-SP120, beam 20° or
- b) Solstice model, item no XIL-S1130, beam 30°

Available from Vision X Lighting South Africa at <https://visionxlighting.co.za/>

Drawing 253-61

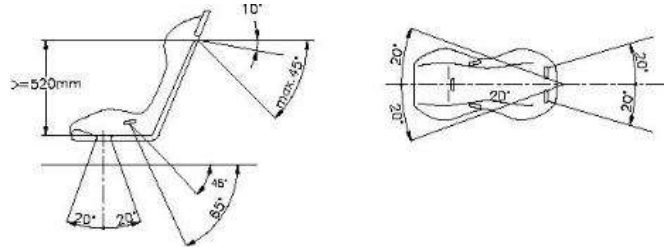

38.5.2 Premium Motorbike Spot 10W

Available from Extreme Lights at <https://www.extremelights.co.za/collections/motorbike-lights>

38.5.3 Lamin-X 20x10cm Mini sheets yellow, to cover the light lens for the yellow colour.

Available from: Autostyle at <https://www.autostyle.co.za/>

39. SAFETY BELTS

39.1 Belts:

- The wearing of a five (5) or six (6)-point harness is compulsory.
- Anchorage points on the shell or the chassis or the cabin or the safety cage: two (2) for the lap strap, two (2) for the shoulder straps, one (1) or two (2) for the pelvic strap(s).
- These belts must comply with GCR 239 as a minimum requirement.
- The ASN's may homologate mounting points on the safety cage when this cage is being homologated, on condition they are tested.

39.2 Installation:

- It is prohibited for the seat belts to be anchored to the seats or their supports.
- The anchorage points of the series vehicle (Lightweight Vehicle Category) must be used.
- If the installation on the series anchorage points is impossible, new anchorage points must be installed on the shell or the chassis or the cabin, a separate one (1) for each strap the furthest rearward as possible for the shoulder straps.
- Care must be taken that the straps cannot be damaged through chafing against sharp edges.
- The recommended geometrical locations of the anchorage points are shown in *Drawing 253-61*.

- In the downwards direction, the shoulder straps must be directed towards the rear and must be installed in such a way that they do not make an angle of more than 45° to the horizontal from the upper rim of the backrest (20° from the driver's shoulders in T4), although it is recommended that this angle should not exceed 10°.
- The maximum angles in relation to the centreline of the seat are 20° divergent or convergent (measurement in horizontal projection).
- If possible, the anchorage point originally mounted by the car manufacturer on the C-pillar must be used.
- Anchorage points creating a higher angle to the horizontal must not be used.
- If mounting on the series anchorages is impossible, the shoulder straps may be fixed or leaning on a rear transverse tube fixed to the cage or to the top anchorage points of the front belts.
- The shoulder straps may also be fixed to the safety cage or to a reinforcement bar by means of a loop and may also be fixed to the top anchorage points of the rear belts or be fixed or leaning on a transverse reinforcement welded between the backstays of the cage (*Refer Drawing 253-66*).

Drawing 253-66

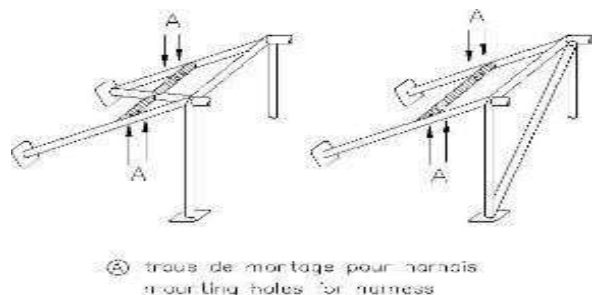

- In this case, the use of a transverse reinforcement is subject to the following conditions:

- The transverse reinforcement must be a tube measuring at least 38mm x 2.5mm or 40mm x 2mm, made from cold drawn seamless carbon steel, with a minimum tensile strength of 350 N/mm².
- The height of this reinforcement must be such that the shoulder straps, towards the rear, are directed downwards with an angle of between 10° and 45° (20° in T4) to the horizontal from the rim of the backrest (or the driver's shoulders in T4), an angle of 10° being recommended.
- The lap and crotch straps must not pass over the sides of the seat but through the seat, in order to wrap and hold the pelvic region over the greatest possible surface. The lap straps must fit tightly in the bend between the pelvic crest and the upper thigh. Under no conditions must they be worn over the region of the abdomen.
- The straps may be attached by looping or by screws, but in the latter case an insert must be welded for each mounting point (Refer Drawing 253-67 for the dimensions).

Drawing 253-67

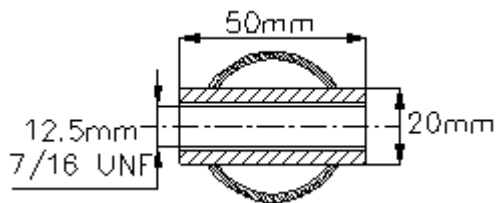

- These inserts must be positioned in the reinforcement tube and the straps must attach to them using bolts of M12 8.8 or 7/16 UNF specification.
- Each anchorage point must be able to withstand a load of 1470 daN, or 720 daN for the crotch straps.
- In the case of one (1) anchorage point for two (2) straps (prohibited for shoulder straps), the load considered must be equal to the sum of the required loads.
- For each new anchorage point created a steel reinforcement plate with a surface area of at least 40 cm² and a thickness of at least 3mm must be used.

39.3 Principles of mounting to the chassis / monocoque:

39.3.1 General mounting system: Refer Drawing 253-62

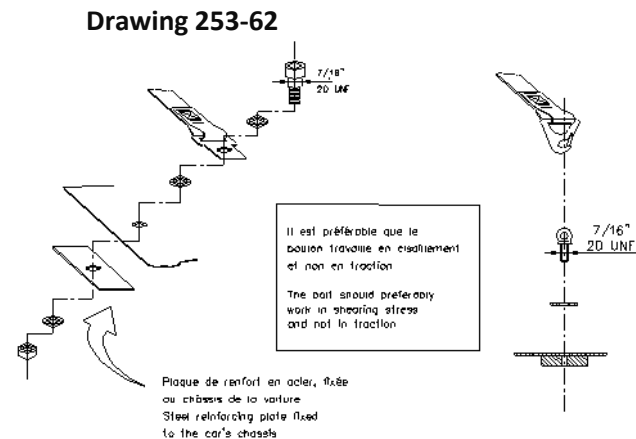

39.3.2 Shoulder strap mounting: Refer Drawing 253-63

Drawing 253-63

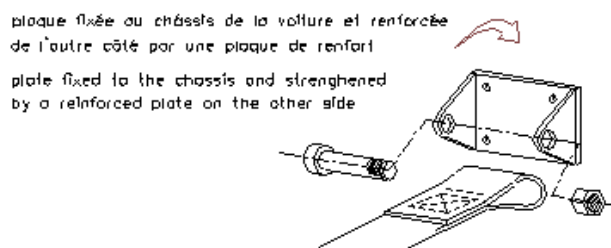

39.3.3 Crotch strap mounting: Refer Drawing 253-64.

Drawing 253-64

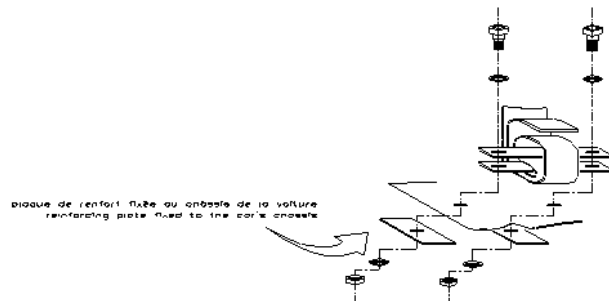

39.4 Use:

- A safety harness must be used in its homologation configuration without any modifications or removal of parts, and in conformity with the manufacturer's instructions.
- The effectiveness and longevity of safety belts are directly related to the manner in which they are installed, used and maintained.
- The belts must be replaced after every severe collision, and whenever the webbing is cut, frayed, or weakened due to the actions of chemicals or sunlight.
- They must also be replaced if metal parts or buckles are bent, deformed, or rusted. Any harness which does not function perfectly must be replaced.

39.5 Note: It is not allowed to mix parts of seat belts. Only complete sets, of proprietary manufacture, may be used.

40. SEATS AND SEAT MOUNTINGS
(FIA APPENDIX J. ART 253.16)

- If the original seat attachments or supports are changed, the new parts must either be approved for that application by the seat manufacturer or must comply with the specifications mentioned below:

40.1 Anchorage points for fixing the seat supports:

- The seat supports must be fixed either:
- on the anchorage points for fixing seats used on the original car
- on the anchorage points for fixing seats homologated by the manufacturer as an "Option Variant" (in which case the original anchorage points may be removed)
- on anchorage points for fixing seats in conformity with Drawing 253-65B.
- The seat supports must be fixed to the anchorage points for fixing seats via at least four (4) mounting points per seat, using bolts measuring at least 8mm in diameter.

40.2 Fixing of the seat supports directly onto the shell/chassis:

- Supports must be attached to the shell/chassis via at least four (4) mounting points per seat using bolts with a minimum diameter of 8mm and counter plates, according to the Drawing 253-65.
- The minimum area of contact between support, shell/chassis and counter plate is 40 cm² for each mounting point.

Drawing 253-65

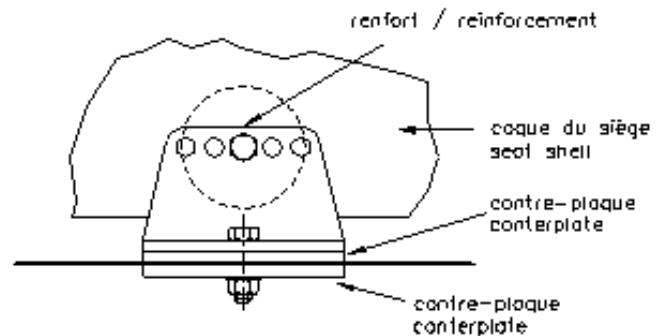

40.3 If quick release systems are used, they must be capable of withstanding vertical and horizontal forces of 18000 N, applied non-simultaneously. If rails for adjusting the seat are used, they must be those originally supplied with the homologated car or with the seat.

40.4 The seat must be attached to the supports via four (4) mounting points, two (2) at the front and two (2) at the rear of the seat, using bolts with a minimum diameter of 8mm and reinforcements integrated into the seat. Each mounting point must be capable of withstanding a force of 15000 N applied in any direction.

40.5 The minimum thickness of the supports and counter plates is three (3)mm for steel and five (5)mm for light alloy materials. The minimum longitudinal dimension of each support is six (6)cm.

40.6 If there is a cushion between the homologated seat and the occupant, the maximum thickness of this cushion is fifty (50)mm. All the occupants' seats must be homologated by the FIA (8855/1999 standard) and not modified. The limit for use is five (5) years from the date of manufacture indicated on the mandatory label. An extension of two (2) further years may be authorised by the manufacturer and must be indicated by an additional label.

Drawing 253-65B

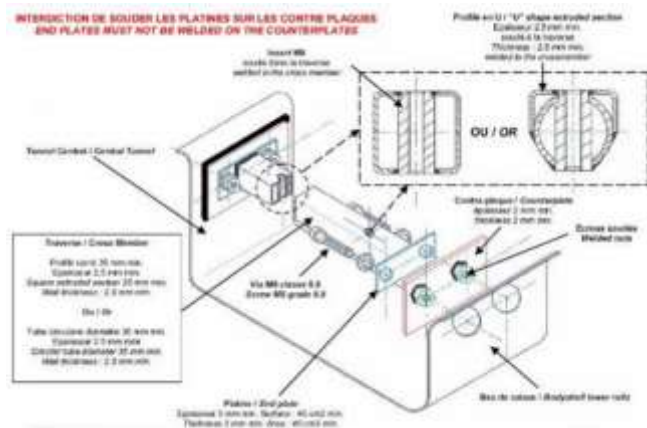

Fitting instructions:

- Drill holes (larger than nut outer diameter) in the body shell lower rail and in central tunnel wall.
- Weld the nuts on the counter plates, then weld these on the body shell lower rail on the central tunnel wall.
- Weld the two (2) threaded inserts in the cross member, then weld the endplates at each end of the cross member.
- Fix the assembly through four (4) x M8 screws of 8.8 grade which will be screwed in the welded nuts.

41. CHASSIS AND SAFETY CAGE

(Applicable from 01/01/2015)

41.1 The chassis must either:

- Derive from a chassis (or monocoque body) of the vehicle specified in the technical passport.
- Or be a tubular frame chassis in ferrous materials only.
- The wall thickness of the tubes forming the structural part of the chassis must not be less than 1.5mm.
- All tubes of the safety cage defined in Drawings 253-1, 253-2, 253-3 must have a minimum section of 50x2mm (2.0"x0.083") or 45x2.5mm (1.75"x0.095").
- Padding in the form of 60-240kg/m³ material, with a minimum thickness of 40mm, must be fitted on the steering wheel over a minimum surface of 20 000 mm² (200 cm²) to protect the driver's face.
- The car must have a structure immediately behind the crew seats that are wider than their shoulders and extends above them when they are seated normally in the car with their seat belts fastened.

Drawing 253-1

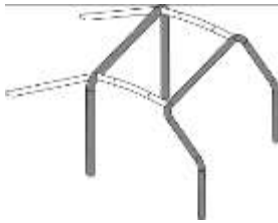

Drawing 253-2

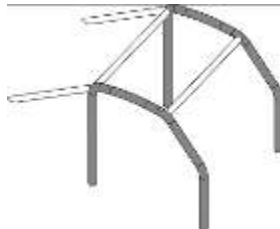

Drawing 253-3

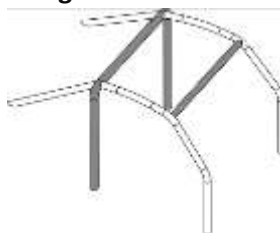

41.2 General:

41.2.1 The fitting of a safety cage is compulsory and must comply with the requirements. The safety cage must be either homologated by the FIA, or accepted by MSA, based on the fulfilment of the requirements as set out in *Art 41.4. (Also Refer Art 31.4)*.

Photographs of the safety cage will be placed in the Technical Passport of the vehicle. No modifications to the safety cage as entered in the passport will be allowed.

In the case where a safety cage has been damaged, it has to be presented to the appointed Chief Scrutineer or TC for inspection, and a proposed repair procedure presented for approval in consultation with the original manufacturer.

The repair will be recorded in the passport.

41.2.2 The safety cage may be either:

- a) Fabricated in compliance with the requirements of the following articles;
- b) Homologated or Certified by MSA according to the Homologation Regulations for safety cages; An authentic copy of the Homologation Document or Certificate, approved by MSA and signed by qualified technicians representing the manufacturer, must be presented to the event's scrutineers. Any new cage which is homologated by MSA and is on sale must be identified by means of an identification plate affixed to it by the manufacturer. This identification plate must be neither copied nor moved (i.e., embedded, engraved or self-destroying sticker). The identification plate must bear the name of the manufacturer, the homologation or certification number of the MSA Homologation Form or Certificate and the individual series number of the Manufacturer. A Certificate bearing the same numbers must be carried on board and be presented to the event's scrutineers.
- c) Homologated by the FIA according to the Homologation Regulations for safety cages. The Manufacturer's identification and a series number must be clearly visible on all cages homologated and sold after 01.01.1997.

The homologation form of the cage must specify how and where this information is indicated, and the purchasers must receive a numbered certificate corresponding to this. Any modification to a homologated or certified safety cage is forbidden. To be considered as a modification, any process made to the cage by machining, welding, that involves a permanent modification of the material or the safety cage. All repairs to a homologated or certified safety cage, damaged after an accident must be carried out by the manufacturer of the Safety Cage or with his approval.

41.2.3 Tubes must not carry fluids or any other item.

41.2.4 The safety cage must not unduly impede the entry or exit of the driver and co-driver.

- The cars must have lateral openings in the safety cage allowing the exit of the driver and possible co- drivers. The dimensions of these openings must be such that it is possible to fit into them a rectangle at least 500mm wide and 500mm high, measured vertically, the corners of which may be rounded with a maximum radius of 150mm.
- The cockpit must be designed so as to allow an occupant to exit from his normal position in the vehicle within seven (7) seconds through the door on his side and within nine (9) seconds through the door on the other side.
- For the purpose of the above tests, the occupant must be wearing all his normal equipment, the seat belts must be fastened, the steering wheel must be in place and in the most inconvenient position and the doors must be closed. These tests must be repeated for all the occupants of the car.

41.3 Definitions:

41.3.1 Safety cage:

Multi-tubular structure installed in the cockpit and fitted close to the body shell, the function of which is to reduce the deformation of the body shell (chassis) in case of an impact.

41.3.2 Roll bar:

Tubular frame forming a hoop with two mounting feet.

41.3.3 Main roll bar: (Drawing 253-1)

Transverse and near-vertical (maximum angle +/-10° to the vertical) single piece tubular hoop located across the vehicle just behind the front seats.

The tube axis must be within one (1) single plane.

41.3.4 Front roll bar: (Drawing 253-1)

Similar to main roll bar but its shape follows the windscreen pillars and top screen edge.

41.3.5 Lateral roll bar: (Drawing 253-2)

Near-longitudinal and near-vertical single piece tubular hoop located along the right or left side of the vehicle, the front pillar of which follows the windscreen pillar and the rear pillar of which is near-vertical and located just behind the front seats.

The rear pillar must be straight inside view.

41.3.6 Lateral half-roll bar: (Drawing 253-3)

Identical to the lateral roll bar but without the rear pillar.

41.3.7 Longitudinal member:

Near-longitudinal single piece tube joining the upper parts of the front and main roll bars.

41.3.8 Transverse member:

Near-transverse single piece tube joining the upper parts of the lateral half-roll bars or of the lateral roll bars.

41.3.9 Diagonal member:

Transverse tube between:

One (1) of the top corners of the main roll bar, or one (1) of the ends of the transverse member in the case of a lateral roll bar, and the lower mounting point on the opposite side of the roll bar or the upper end of a backstay and the lower mounting point of the other backstay.

41.3.10 Removable members:

Members of a safety cage which must be able to be removed.

41.3.11 Cage reinforcement:

Member added to the safety cage to improve its strength.

41.3.12 Mounting foot:

Plate welded to the end of a roll bar tube to permit its bolting to the body shell/chassis, usually onto a reinforcement plate. This plate may be welded to the body shell/chassis in addition to the bolts.

41.3.13 Reinforcement plate:

Metal plate fixed to the body shell/chassis under a roll bar mounting foot to better spread the load onto the body shell/chassis.

41.3.14 Gusset: (Drawing 253-34)

- Reinforcement for a bend or junction made from bent sheet metal with a U shape the thickness of which must not be less than 1.0mm.
- The ends of this gusset (point E) must be situated at a distance from the top of the angle (point S) of between two (2) to four (4)

times the outer diameter of the biggest of the tubes joined. A cut-out is permitted at the top of the angle, but its radius (R) must be no greater than 1.5 times the outer diameter of the biggest of the tubes joined. The flat sides of the gusset may have a hole the diameter of which must not be greater than the outer diameter of the biggest of the tubes joined.

Drawing 253-34

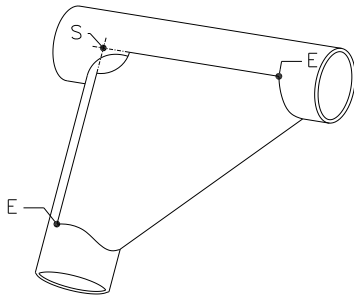

41.4 Specifications:

41.4.1 Basic structure:

- The basic structure must be made according to one of the following designs:
- 1 main roll bar + 1 front roll bar + 2 longitudinal members + 2 backstays + 6 mounting feet (Drawing 253-1) or
- 2 lateral roll bars + 2 transverse members + 2 backstays + 6 mounting feet (Drawing 253-2) or main roll bar + 2 lateral half-roll bars + 1 transverse member + 2 backstays + 6 mounting feet (Drawing 253-3)
- The vertical part of the main roll bar must be as close as possible to the interior contour of the body shell and must have only one bend with its lower vertical part.
- The front pillar of a front roll bar or of a lateral roll bar must follow the windscreen pillars as closely as possible and have only one (1) bend with its lower vertical part.
- In order to build the safety cage, the connections of the transverse members to the lateral roll bars, the connections of the longitudinal members to the front and main roll bars, as well as the connection of a semi-lateral roll bar to the main roll bar must be situated at the roof level.
- In all cases, there must not be more than four (4) removable connections at the roof level.

- The backstays must be attached near the roofline and near the top outer bends of the main roll bar, on both sides of the car, possibly by means of removable connections.
- They must form an angle of at least 30° with the vertical, must run rearwards and be straight and as close as possible to the interior side panels of the body shell.

41.4.2 Design:

- Once the basic structure is defined, it must be completed with compulsory members and reinforcements (*Refer Article 253-8.3.2.1*), to which optional members and reinforcements may be added (*Refer Article 253-8.3.2.2*).
 - Unless explicitly permitted and unless dismantlable joints are used in compliance with *Article 253-8.3.2.4*, all members and tubular reinforcements must be single pieces.
- a) Compulsory members and reinforcements:
- i) Diagonal member:
 - The cage must have one (1) of the diagonal members defined by:
 - *Drawings 253-4 to 253-7* for cars homologated before 01.01.2008.
 - *Drawings 253-6* (Groups T1 and T3 only) and *253-7* for cars homologated as from 01.01.2008.
 - The orientation of the diagonal of *Drawings 253-4* and *253-5* may be reversed.
 - In the case of *Drawing 253-6*, the distance between the two (2) mountings on the body shell/chassis must not be greater than 400mm.
 - Members must be straight and may be removable.
 - The upper end of the diagonal must join the main roll bar no further than 100mm from its junction with the backstay, or the backstay no more than 100mm from its junction with the main roll bar (*Refer Drawing 253-52* for the measurement).
 - The lower end of the diagonal must join the main roll bar or the backstay no further than 100mm from the mounting foot (except for the case of *Drawing 253-6*).

Drawing 253-4

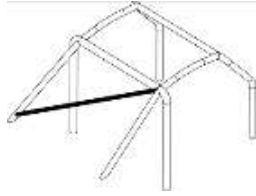

Drawing 253-5

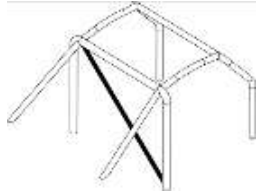

Drawing 253-6

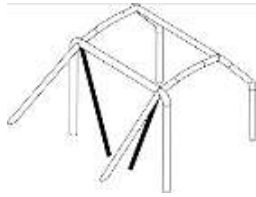

Drawing 253-7

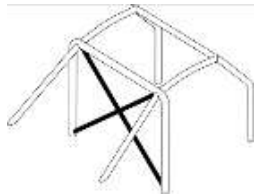

ii) *Door bars:*

- At least one longitudinal strut must be fitted on each side of the vehicle at door level (*Refer Drawing 253-8*). The tube(s) making up this reinforcement must be built into the Safety Cage and its (their) angle with the horizontal tube must not exceed 15° (angled downwards towards the front).
- The design must be identical on both sides.
- The lateral protection must be as high as possible and, if it comprises a single bar, at least 10 cm from the bottom of the seat, but in all cases its upper attachment points must not be higher than half the total height of the door measured from its base.
- If these upper attachment points are located in front of or behind the door opening, this height limitation is also valid for the corresponding intersection of the strut and the door opening.

- In the case of door bars in the form of an "X" (*Drawing 253-9*), it is recommended that the lower attachment points of the cross-struts be fixed directly onto the longitudinal member of the body shell/chassis and that at least one part of the "X" be a single-piece bar. Drawings may be combined.
- The connection of the door bars to the windscreen pillar reinforcement (*Drawing 253-15*) is authorised.
- For competitions without co-driver, members may be fitted on the driver's side only and it is not compulsory for the design to be identical on both sides.

Drawing 253-8

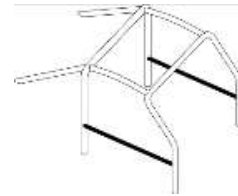

Drawing 253-9

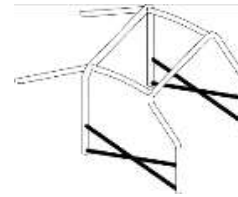

iii) Transverse member: (*Drawing 253-29*)

- The transverse member fixed to the front roll bar is compulsory, but it must not encroach upon the space reserved for the occupants.
- It must be straight.
- It may be placed as high as possible, but its lower edge must not be higher than the uppermost point of the dashboard.
- For cars homologated as from 01.01.2007, it must not be positioned below the steering column.

Drawing 253-29



iv) Roof reinforcement:

- Cars homologated as from 01.01.2005 only:
- The upper part of the safety cage must comply with one of *Drawings 253-12, 253-13 and 253-14*. The reinforcements may follow the curve of the roof.
- For competitions without co-drivers, in the case of *Drawing 253-12* only, only one diagonal member may be fitted but its front connection must be on the driver's side.
- The ends of the reinforcements must be less than 100 mm from the junction between roll bars and members (not applicable to the top of the V formed by reinforcements in *Drawings 253-13 & 253-14*).
- Junction of tubes at the top of the V:
- If the tubes do not join each other, the distance between them must not be more than 100mm at their connection with the roll bar or the transverse member.

Drawing 253-12

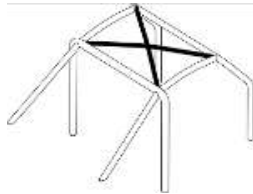

Drawing 253-13

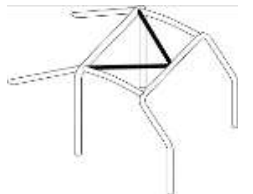

Drawing 253-14

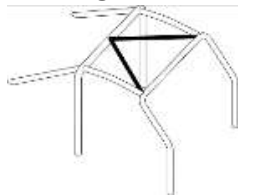

v) Windscreen pillar reinforcement:

- It must be fitted on each side of the front roll bar (*Drawing 253-15*).
- It may be bent on condition that it is straight in side view and that the angle of the bend does not exceed 20°.
- Its upper end must be less than 100mm from the junction between the front (lateral) roll bar and the longitudinal (transverse) member.

- Its lower end must be less than 100mm from the (front) mounting foot of front (lateral) roll bar (Refer *Drawing 253-52* for the measurement).

Drawing 253-15

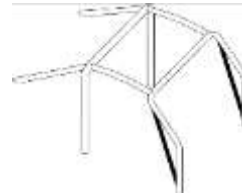

- b) i) Roof reinforcements: (*Drawings 253-12 to 253-14 and 253-23 to 253-24*)
- Only optional for cars homologated before 01.01.2005.
 - For competitions without co-drivers, in the case of *Drawing 253-12* only, one (1) diagonal member only may be fitted but its front connection must be on the driver's side.
 - Members shown in *Drawings 253-23 and 253-24* may be made from two (2) tubes.
- ii) Backstay diagonals: (*Drawings 253-20 and 253-21*)
- The configuration of *Drawing 253-21* may be replaced with that of *Drawing 253-22* if a roof reinforcement complying with *Drawing 253-14* is used.
- iii) Front suspension mounting points: (*Drawing 253-25*)
- The extensions must be connected to the front suspension top mounting points.
- iv) Transverse members: (*Drawing 253-26 to 253-28 and 253-30*)
- Transverse members fitted on the main roll bar or between the backstays may be used for the safety harness mountings in accordance with *Article 253-6.2* (use of dismountable joints prohibited).
 - For members shown on *Drawings 253-26 and 253-27*, the angle between the central leg and the vertical must be at least 30°.
- v) Reinforcement of bends or junctions: (*Drawings 253-31 to 253-34*)
- Reinforcements must be made of tubes or bent-sheet metal with U shape complying with *Article 283-8.2.14*.
 - The thickness of the components forming a reinforcement must not be less than 1.0mm.
 - The ends of the tubular reinforcements must not be more than halfway down or along the members to which they are attached, except

for those of the junction of the front roll bar, which may join the junction of the door strut/front roll bar;

- vi) Mounting of the lifting jacks:
 - For Group T1 and T3 cars, the lifting jacks may be fixed to the safety cage.

Drawing 253-16

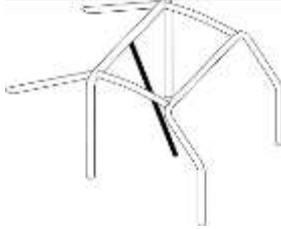

Drawing 253-17

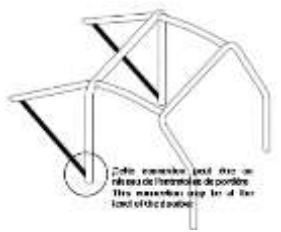

Drawing 253-18

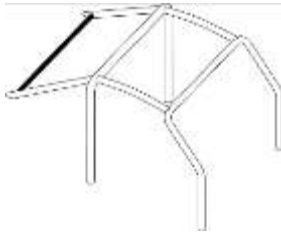

Drawing 253-19

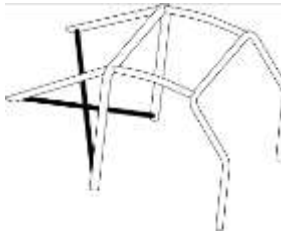

Drawing 253-20

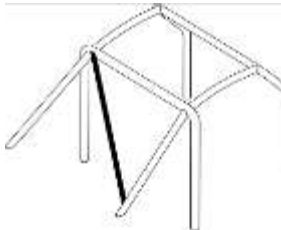

Drawing 253-21

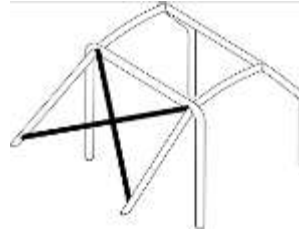

Drawing 253-22

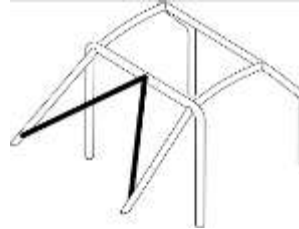

Drawing 253-23

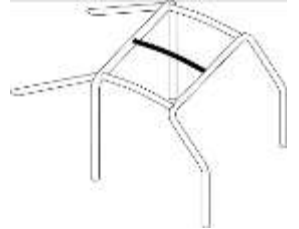

Drawing 253-24

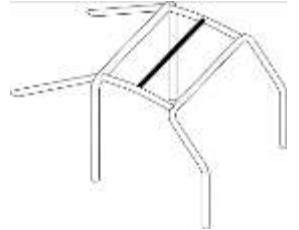

Drawing 253-25

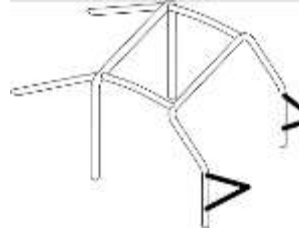

Drawing 253-26

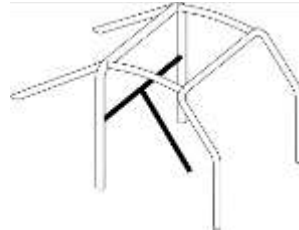

Drawing 253-27

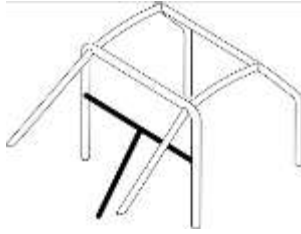

Drawing 253-28

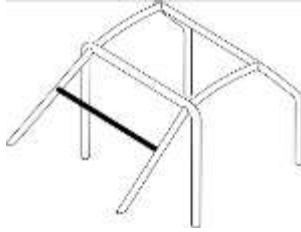

Drawing 253-30



Drawing 253-31

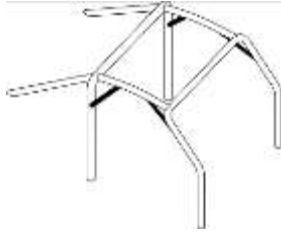

Drawing 253-32

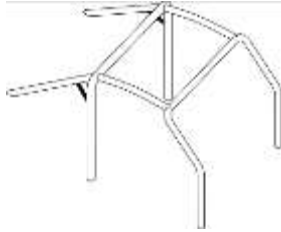

Drawing 253-33

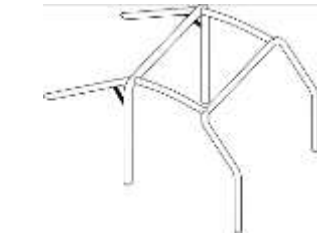

- c) Minimum configuration of the safety cage:
The minimum configuration of a safety cage is defined as follows.

Cars homologated	With co-driver	Without co-driver
Before 01.01.2005	Drawing 283-1A	Drawing 283-2A or symmetrical
As from 01.01.2005	Drawing 283-1B	Drawing 283-2B or symmetrical

- The diagonal member may vary according to *Article 283-8.3.2.1.1*. Roof reinforcement may vary according to *Article 283-8.3.2.1.4*.
- In the case of a car with a crew of three (3), the safety cage must comply with Drawing 283-3, with a second main roll bar situated close to the back(s) of the rear seat(s).
- With regard to pick-up vehicles, the cockpit of which is not large enough to allow the fitting of the compulsory basic safety cage, it is possible to mount the roll bar(s) as per one of the *Drawings 283-4 to 283-7*.
- This possibility is open to pick-ups only, to the exclusion of all other types of bodywork and all the points of the installation must comply with the prescriptions of the other paragraphs (including the material specifications of *Article 283-8.3.3*).
- *Drawing 283-4*: one (1) diagonal strut compulsory.
- *Drawing 283-5*: two (2) diagonal struts compulsory, one (1) for the four (4)-point cage inside the cockpit (according to *Drawing 253-5*), one (1) for the four (4)-point outside cage (according to *Drawing 253-4 or 253-5*).
- *Drawing 283-6*: one (1) diagonal strut compulsory (according to *Drawing 253-4 or 253-5*).
- *Drawing 283-7*: two (2) diagonal struts compulsory, one (1) for the interior four (4)-point cage, one (1) for the exterior six (6)-point cage.

Drawing 283-1A

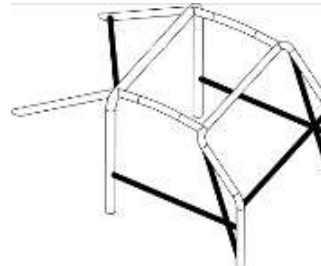

Drawing 283-1B

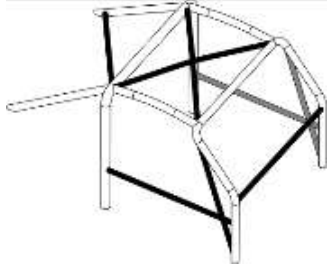

Drawing 283-2A

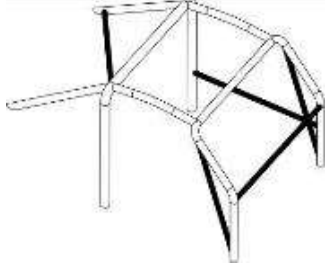

Drawing 283-2B

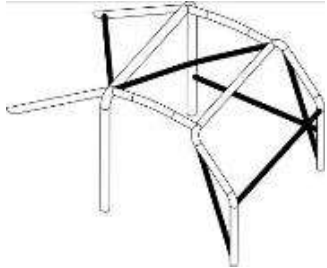

Drawing 283-3

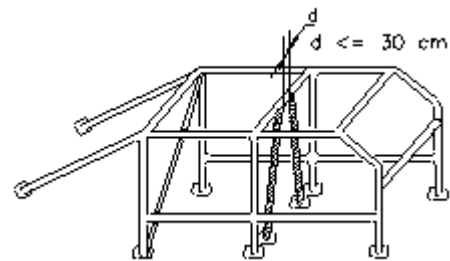

Drawing 283-4

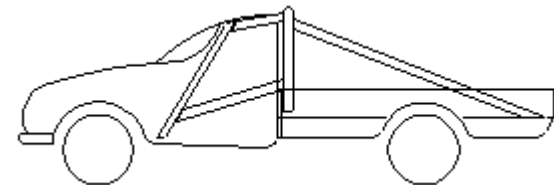

Drawing 283-5

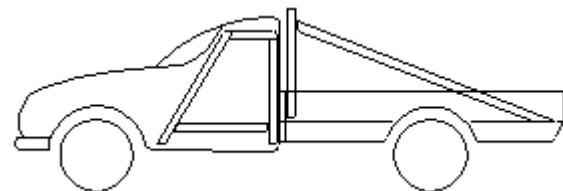

Drawing 283-6

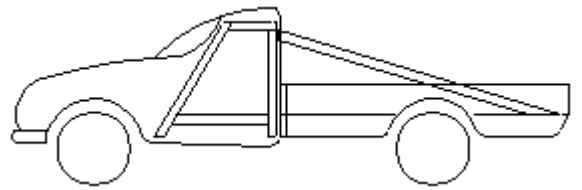

Drawing 283-7

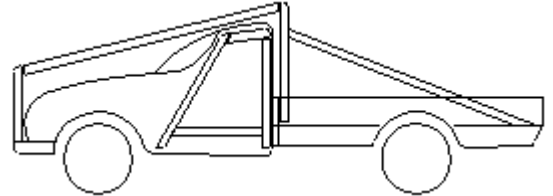

d) Removable members:

- Should removable members be used in the construction of a safety cage, the dismantlable joints used must comply with a type approved by the FIA (*Drawings 253-37 to 253-47*).
- The removable connections must be fitted within the extension of the axis of the tubes and must not be offset.
- They must not be welded once assembled.
- The screws and bolts must have a minimum quality of 8.8 (ISO standard).
- Dismountable joints complying with *Drawings 253-37, 253-40, 253-43, 253-46* and *253-47* are solely for attaching optional members and reinforcements described by *Article 283-8.3.2.2* and are forbidden for joining the upper parts of the main roll bar, of the front roll bar, of the lateral half-roll bars and of the lateral roll bars.

Drawing 253-37

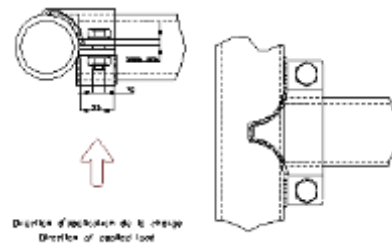

Drawing 253-38

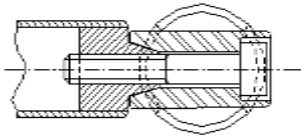

Drawing 253-39

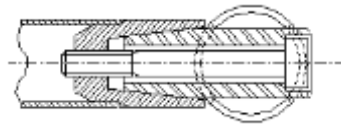

Drawing 253-40

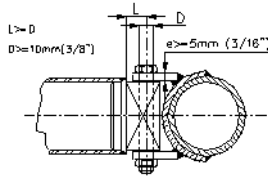

Drawing 253-41

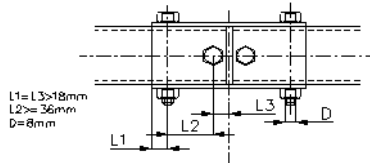

Drawing 253-42

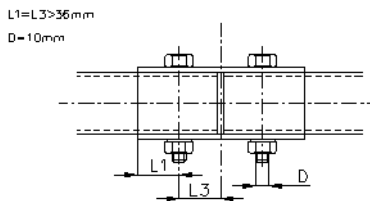

Drawing 253-43

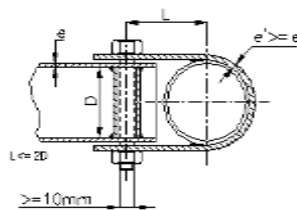

Drawing 253-44

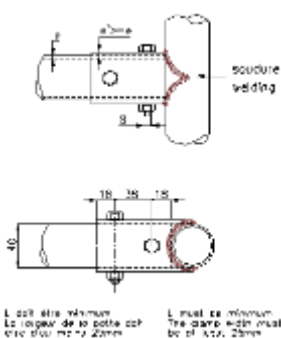

Drawing 253-45

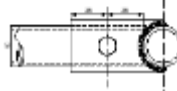
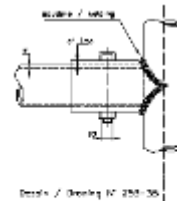

Drawing 253-46

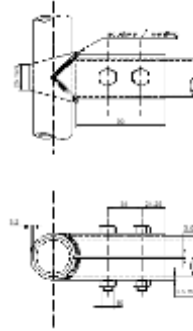

Drawing 253-47

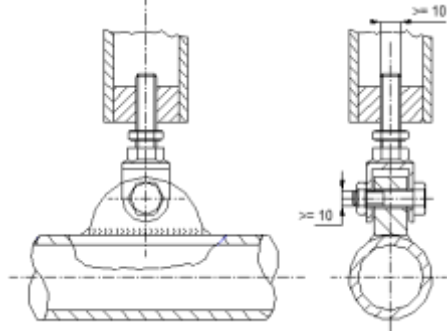

e) Additional constraints:

- The safety cage must be entirely contained between the following limits:
- 200mm in front of the front wheel axis,
- rear wheel axis.
- Nevertheless, the backstays may extend beyond this plane to be attached to the chassis.
- The rear backstays on a monocoque chassis may extend beyond the rear suspension mounting points, provided that they are fixed or welded onto a hollow body of the monocoque chassis.
- The rear face of the headrest subjected to the regulation load defines the position of the tube of the main roll bar which may not protrude beyond it in vertical projection.

- The minimum distance between the occupants' helmets and the tubes of the safety cage must not be less than 50mm.
- f) Mounting of Safety Cage to the bodyshell/chassis:
- The safety cage must be fixed directly to the steel bodyshell or the main chassis, i.e., onto the structure to which the suspension loads are transmitted (with, if necessary additional reinforcement at the joint between the chassis and the foot of the roll bar).
 - Minimum mounting points are:
 - One (1) for each pillar of the front roll bar;
 - One (1) for each pillar of the lateral roll bars or lateral half-roll bars;
 - One (1) for each pillar of the main roll bar;
 - One (1) for each backstay.
 - To achieve an efficient mounting to the bodyshell, the original interior trim may be modified around the safety cages and their mountings by cutting it away or by distorting it however, this modification does not permit the removal of complete parts of upholstery or trim. Where necessary, the fuse box may be moved to enable a Safety Cage to be fitted.
 - Mounting points of the front, main, lateral roll bars, or lateral half-roll bars: Each mounting point must include a reinforcement plate at least three (3)mm thick.
 - Each mounting foot must be attached by at least three bolts on a steel reinforcement plate at least three (3)mm thick and of at least one hundred and twenty (120)cm² area which is welded to the bodyshell.
 - For cars homologated as from 01.01.2007, the area of 120cm² must be the contact surface between the reinforcement plate and the bodyshell.
 - Examples according to *Drawings 253-50 to 253-56*.
 - For *Drawing 253-52*, the reinforcement plate need not necessarily be welded to the bodyshell.
 - In the case of *Drawing 253-54*, the sides of the mounting point may be closed with a welded plate. Fixing bolts must have a minimum diameter of M8 and a minimum quality of 8.8 (ISO standard).
 - Fasteners must be self-locking or fitted with lock washers.
- The angle between two (2) bolts (measured from the tube axis at the level of the mounting foot cf. *Drawing 253-50*) must not be less than sixty (60) degrees. Mounting points of the backstays:
 - Each backstay must be secured by a minimum of two (2) M8 bolts with mounting feet of at least sixty (60)cm² area (*Drawing 253-57*) or secured by a single bolt in double shear (*Drawing 253-58*), provided it is of adequate section and strength and provided that a bush is welded into the backstay. Their mountings must be reinforced by plates.
 - These are minimum requirements.
 - In addition, more fasteners may be used, the support plates of the mounting feet may be welded to reinforcement plates, the safety cage (as defined by *Article 283-8.3.1*) may be welded to the bodyshell/chassis.
 - Special case:
 - Diagonal members fixed to the bodyshell (*Refer Drawing 253-6*) must have reinforcement plates as defined above.
 - For non-steel bodyshells/chassis, any weld between the cage and the bodyshell/chassis is prohibited, only the bonding of the reinforcement plate on the bodyshell/chassis is permitted.
 - Safety Cages equipping vehicles with a tubular or semi-tubular space frame (Groups T1 and T3) must be welded to the chassis or be an integral part of it.
 - The mounting points of the front, lateral, semi-lateral and main roll bars must be situated at least at the level of the cockpit floor.
 - At least one tube of the same section and quality must extend each foot of the roll bar downwards. Another diagonal is recommended, as well as a horizontal tube at floor level.

Drawing 253-50

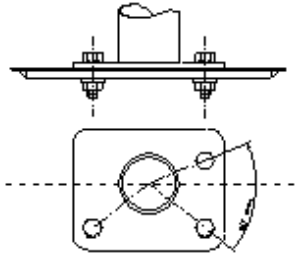

Drawing 253-54

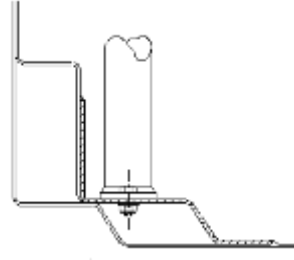

Drawing 253-51

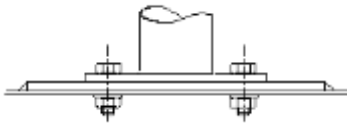

Drawing 253-55

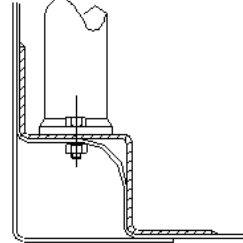

Drawing 253-52

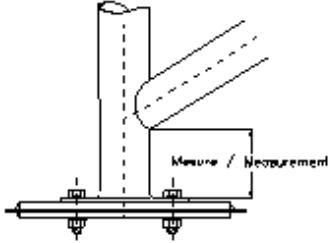

Drawing 253-56

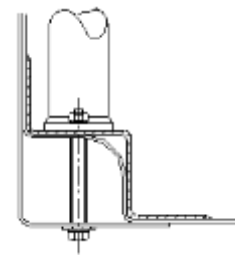

Drawing 253-53

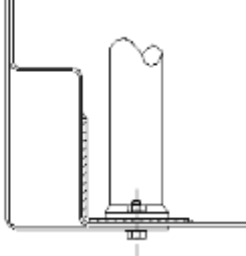

Drawing 253-57

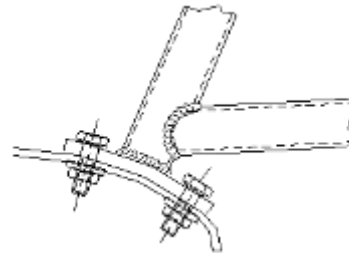

Drawing 253-58

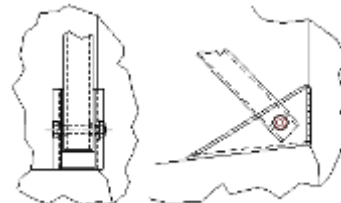

41.4.3 Material Specifications

Only tubes with a circular section are authorised.

Specifications of the tubes used:

Material	Minimum tensile strength	Minimum dimensions (mm)	Use
Cold drawn seamless unalloyed carbon steel (see below) containing a maximum of 0.3 % of carbon	350 N/mm ²	45 x 2.5 (1.75"x0.095") or 50 x 2.0 (2.0"x0.083")	Main roll bar (Drawings 253-1 and 253-3) or Lateral roll bars and Rear transverse member (Drawing 253-2)
		38 x 2.5 (1.5"x0.095") or 40 x 2.0 (1.6"x0.083")	Lateral half-roll bars and other parts of the safety cage (unless otherwise indicated in the articles above)

Note:

- These figures represent the minima allowed.
- In selecting the steel, attention must be paid to obtaining good elongation properties and adequate weldability.
- The tubing must be bent by a cold working process and the centreline bend radius must be at least three (3) times the tube diameter.
- If the tubing is ovalised during bending, the ratio of minor to major diameter must be zero point nine (0.9) or greater. The surface at the level of the bends must be smooth and even, without ripples or cracks.

41.4.4 Guidance on welding:

- These must be carried out along the whole perimeter of the tube. All welds must be of the highest possible quality with full penetration and preferably using a gas-shielded arc.

- Although good external appearance of a weld does not necessarily guarantee its quality, poor looking welds are never a sign of good workmanship.
- When using heat-treated steel, the special instructions of the manufacturers must be followed (special electrodes, gas protected welding).

41.4.5 Protective padding:

- Where the occupants' bodies could come into contact with the safety cage, flame retardant padding must be provided for protection.
- Where the occupants' crash helmets could come into contact with the safety cage, the padding must comply with *FIA standard 8857-2001, type A (Refer technical list n°23 "Roll Cage Padding Homologated by the FIA")* and must be permanently fixed to the cage. Application: For all categories.

PART IV - VEHICLE CLASSES

42. SPECIAL VEHICLE AND LIGHTWEIGHT VEHICLE CATEGORIES CLASSES

NOTES:

- 42.1 Competitors contemplating the purchase, or construction, of a new vehicle for any of the Classes must ensure that the specifications and design are acceptable to the Controllers, or their designated representative, and acceptance has been confirmed in writing and signed by the Chairman. Refer ART 31.4 and 31.7.
- 42.2 For safety reasons crews in all Classes with the exception of Class B must consist of two (2) persons. Crew/s in Class B may consist of one (1) or two (2) persons.

43 GENERAL REGULATIONS – ALL SPECIAL VEHICLE & LIGHTWEIGHT CATEGORY VEHICLES

- 43.1 No racing vehicle may have any forward or rearward protruding metal parts past the front and rear most transverse metal structure.
- 43.2 Vehicles must be fitted with sturdy towing eyes front and rear, in a visible and accessible position, painted red or orange.
- 43.3
- 43.3.1 Titanium or magnesium materials are not allowed, unless they are fitted as standard parts on Committee Approved (CA) assemblies.
- 43.3.2 Carbon fibre and Kevlar materials are not allowed other than for specific aesthetic use only, e.g., one layer for dashboard panels, air cleaner assemblies, air ducts, selected body panels. Multi layers of Kevlar may be used for genuine stone protection areas.
- 43.4 Air cleaner system free and position free. Should air be passed through the passenger compartment only a pipe with a maximum diameter of one hundred and ten (110)mm may be used. Restrictors must be in the engine compartment. Refer Art 33.2
- 43.5 No traction-, launch- or vector control, ABS, electronically controlled active suspension, or any closed-loop electronic control system whatsoever, except engine management, may be used. No pneumatic or hydraulic suspension allowed, only mechanical. Steering must be direct mechanical with hydraulic or electrical assistance.
- 43.6 An on-board tyre “deflation/inflation system” may not be used in the Special Vehicle or Side by Side Vehicle categories.
- 43.7 An on-board vehicle jacking system may not be used in the Special Vehicle or Side by Side Vehicle categories.
- 43.8 Telemetry is not permitted, but on-board data logging is allowed.
- 43.9 Fasteners used throughout the vehicle are free. Ferrous materials only.
- 43.10 On-board fire protection system is recommended for all vehicles competing in this Category. Refer Art 36.
- 43.11 The use of electronic devices for communication (two-way radios/cell phones/intercoms) purposes are allowed. Only GPS equipment complying with Part I, ART 2.8 will be permitted for route finding.
- 43.12 The vehicle shall be constructed to accommodate a crew of two (2), or in the case of Class B, the vehicle shall be constructed to accommodate a crew of one (1) or two (2).
- 43.13 All spare wheels must be securely fastened when on the vehicle.
- 43.14 The safety cage, body and cockpit of the vehicle must be built so that it is possible to allow the crew to escape in an emergency. Refer Art 41. The crew must be able to exit the vehicle unaided within seven (7) seconds on either side of the vehicle. The appointed Chief Scrutineer or TC may request test runs to prove this.
- A standard production homologated safety glass windscreen must be used.
 - If the front windscreen is glued or otherwise permanently fixed, then it must be possible to remove the side windows or doors without tools, to allow the crew to escape in an emergency. Driver and Navigator must be able to exit the vehicle unaided within seven (7) seconds on either side of the vehicle.

- All other glass may be replaced with polycarbonate material, Lexan F2000 sheet or equivalent, minimum thickness three (3)mm. Refer ART 35.

43.15 Fuel, Refer Art 32.15

Fuel tanks must have sufficient capacity to complete 175 kilometres of racing. Refer ART 18.1

43.16 Speed limits: a general speed limit will be applicable to all Classes at all events. These speed limits may not be exceeded. Refer Part I, Refer ART 5.4 & 20.1.1 (h).

44 CLASS A | SPECIAL VEHICLES - TWO WHEEL DRIVE

44.1 There are no restrictions on chassis or suspension in this Class, but Art 42.1 takes precedence.

44.2 The body fitted to a vehicle competing in this Class may not resemble a body fitted to a production vehicle and shall not display any current production vehicle brand name. No obvious aerodynamic assistance will be allowed.

44.3 Engines:

44.3.1 All engines for Class A must be registered in the Technical Passport. New engines must be Committee Approved. Only normally aspirated (NA), standard Gp N petrol engines with capacity not exceeding 6300cc will be allowed.

44.3.2 Engines not complying with the Regulations may be allowed to run under deviation with balance of performance applied.

44.3.3 Committee Approved engines:

Chevrolet LS 3 crate engine, part no.19369326, max capacity 6162cc, max compression ratio 10,7:1, standard inlet manifold and throttle body. No engine modifications allowed.

Exhaust manifold and systems are free, but must be made from steel, and conform to Art 34.

44.4 Transmission:

Vehicles are restricted to two-wheel drive. Gearbox and other drive details are free but must be mechanical engine to wheel. No electrical, pneumatic, or hydro-static drives are allowed. Torque converters are allowed.

45 CLASS B | SPECIAL VEHICLES - TWO WHEEL DRIVE

45.1 Engines:

45.1.1 Any normally aspirated four-cylinder petrol engine with a cubic capacity of no greater than 2050cc may be used. The engine must originate from any series production car or commercial vehicle that is available from retail engine outlets in South Africa, and the engine must be clearly recognisable as such.

45.1.2 Engine modifications permitted:

The original cylinder head, cylinder block and crankshaft must be retained otherwise modifications are unrestricted.

45.1.3 The Nissan SR20 VVL Neo engine may be used.

45.1.4 Rotary engines are not allowed in Class B.

45.2 There are no restrictions on chassis, body, suspension in this Class, crew may comprise of one person in the case of single-seater vehicles or two (2) persons in the case of twin-seater vehicles.

45.3 There are no restrictions on induction air or weight in this Class.

45.4 Transmission:

Vehicles are restricted to two-wheel drive. Gearbox and other drive details are free but must be mechanical engine to wheel. No electrical, pneumatic, or hydro-static drives are allowed. Torque converters are allowed.

46 CLASS P | SPECIAL VEHICLES - TWO WHEEL DRIVE

- 46.1 There are no restrictions on chassis or suspension in this Class, but *ART 43.1* takes precedence.
- 46.2 The body fitted to a vehicle competing in this Class may not resemble a body fitted to a production vehicle and shall not display any current production vehicle brand name. No obvious aerodynamic assistance will be allowed.
- 46.3 Engines:
All engines for Class P must be registered in the Technical Passport. New engines must be Committee Approved (C.A.) Only normally aspirated (NA); standard Gp N petrol engines will be allowed.
- 46.3.1 Committee Approved engines:
- Gp N standard, normally aspirated, 6-cylinder petrol engines with a cubic capacity of not greater than 4300cc.
 - The engine must originate from any production car or commercial vehicle that is available from retail outlets in South Africa, and the engine must be clearly recognisable as such. Engines must retain the original unmodified intake manifold.
 - The throttle body is free but must retain the standard throttle valve diameter. It may be converted from fly by wire to mechanical operation and vice versa.
 - The fitting of a Gp N standard 4000cc Lexus engine 1UZ-FE V8 engine and the Gp N std 4300cc Lexus 3UZ-FE V8 engine is allowed.
- 46.4 Exhaust manifold and systems are free, but must be made from steel, and conform to *ART 34*.
- 46.5 Transmission:
Vehicles are restricted to two-wheel drive. Gearbox and other drive details are free but must be mechanical engine to wheel. No electrical, pneumatic, or hydro-static drives are allowed. Torque converters are allowed.

47 CLASS G (SXS) | LIGHTWEIGHT VEHICLES – TWO- OR FOUR-WHEEL DRIVE

- 47.1 Sporting Regulations: Lightweight Vehicle Category
- 47.1.1 Class G (SXS) will fall into the Category Lightweight Vehicles.
The SXS Class will use “G” numbers.
- 47.1.2 *ART 47* must be read in conjunction with *Parts I, III* and *ART 43.1* which takes precedence where included.
- 47.1.3 All Class SXS vehicles must comply with the SXS technical Regulations
- a) Vehicle Technical Regulations: Class Side by Side (SXS)-MSA or
 - b) *ART 47.3 Vehicle Technical Regulations: Class Side by Side (SXS)-FIA T3 and T4*
- 47.1.4 Balance of Performance
Both Classes may be subject to Balance of Performance measures. The parameters turbo boost, intake restrictors, race weight, maximum engine rpm, but not limited to will be used to control performance parity. *PART III | ART 33*
- 47.1.5 Crew
The vehicle shall always race with two (2) crew members appropriately licenced by MSA.
- 47.1.6 Maximum speed
The maximum speed shall be limited to 140km/h. The onus is on the competitors to set their ECU speed limits to the maximum allowed, with a safe margin. *Refer Part I, Refer ART 5.4 & 20.1.1 (h)*.
- 47.1.7 Weight
The minimum weight shall not be less than 900 kg when weighed at any time during the event. Weighed with one (1) spare wheel. For method of weighing refer to *ART 33.1*
- 47.1.8 Number board
All vehicles must bear the series allocated competition numbers on the number panels as detailed in *Part I, ART 3.4*. A durable competition number panel 250(h) x 350(w)mm must be permanently fitted high on both rear sides of the vehicle where it is clearly visible to marshals and spectators. The panel must be protected against branches sweeping the side of the vehicle.

The onus is on the competitor to ensure that the competition numbers are always visible and legible.

47.2 Vehicle technical Regulations: Class Side by Side (SXS) - MSA

47.2.1 Vehicles

- The Production Recreational Vehicle Class consisting of mass produced four-wheeled SXS vehicles commercially available, imported by recognised vehicle importers.
- Main vehicle dimensions based on T3/T4:
- The maximum width of the bodywork without rear view mirrors and/or spare wheels: 1900mm.
- Wheelbase: that of the reference vehicle ± 50 mm.
- Front and rear axle width measured at vertical wheel centre not to exceed: 1900mm.
- Front and rear overhangs: identical to the reference vehicle ± 50 mm (spare wheels, mudflaps and their supports not included).

47.2.2 Engine

- Naturally aspirated or turbo, petrol or diesel, engines.
- The engine shall be the OEM unit from the applicable vehicle, mounted in the standard position. The engine mountings may be reinforced.
- The engine shall be in standard OEM Gp N trim.

Refer Part III, ART 32.1

- The engine fuel and breathing system:

- a) The Can-Am ECU may be used, or any single ECU which is freely commercially available over the counter or from a widely published catalogue.
- b) The fuel injection system, injectors, fuel rail, high pressure fuel pump, fuel pressure regulator, pipes must remain standard 2020 OEM. Older cars may be updated to the 190hp 2020 injector and high-pressure fuel pump.
 - 2017 to 2019 CanAm injector part no: 420874845
 - 2020 to 2021 CanAm injector part no: 420874858
 - 2017 CanAm fuel pump part no: 709000836
 - 2020 CanAm fuel pump part no: 709001057

- The CanAm specified maximum fuel pressure is 450 ± 14 kPa. The pressure regulator is an integral part of the fuel pump and may not be modified. There may be no connection between the fuel pressure regulator and the inlet manifold or anywhere else. No additional pumps, regulators, accumulators, etc., will be allowed in the fuel system. A connection point for a fuel pressure gauge must be provided on the fuel rail or fuel lines as required by the TC.

- c) No water, gas or any substance may be injected into the engine air intake at all. Only clean atmospheric air.

- d) The inlet manifold and throttle body assembly must remain standard OEM. Throttle valve diameter is 46mm.

e) Turbochargers

- Pre-2020 cars may be upgraded to the 2020 190hp specification Rotax turbocharger which may not be exceeded.

- Specification 2020 OEM Rotax turbocharger:

- Rotax part no: 893733
- compressor wheel:
 - inducer diam. 36,4mm
 - exducer (taper tip) diam. 39,6mm
- number of blades 6
- compressor housing:
 - inlet diam. (smallest) 37,5mm
 - outlet diam. TBA
- turbine wheel:
 - inducer diam. TBA.
 - exducer diam. TBA.
- number of blades. 11.
- turbine housing:
 - inlet diam. (smallest) TBA.
 - outlet diam. TBA.

- The Standard OEM Rotax turbocharger may be repaired to the following specification from Stallion Turbo's, Hercules, Pretoria. Repair may only be done after damage inspection and written approval by the Controllers.

- Specification Stallion refurbished Rotax turbocharger:

- compressor wheel, 11 blades:
 - inducer diam. 40,0mm
 - exducer (taper tip) diam. 54,5mm
 - exducer (base) 50,1mm
- compressor inlet housing diam. 41,0mm
- turbine wheel and housing. TBA

- f) Holes drilled for sealing, *refer ART 33.3.7*
- g) All engine management sensors must be standard OEM, functional and operational. The following sensors may be added in addition: three (3) temperatures; one (1) pressure; one (1) fuel level.
 - Cooling system water radiators may be upgraded and relocated. Original OEM standard oil cooler must be used. Water and oil lines may be changed for relocation, but diameters may not change.
 - Air ducting and air fans may be changed or added. Fuel cooling not allowed. Charge air cooler single OEM standard. Upgrade to single 2020 CanAm charge air cooler will be allowed. Part no 07800840. OEM water pump to remain in place, unmodified and operational. Additional pumps may be added externally from the engine in the lines.
 - Air filter and ducting is free upstream of the throttle body (NA) or upstream of the turbo inlet.
 - Exhaust system. Free after turbo. Exhaust exit must be horizontal or slope upwards, not protrude beyond the vertical projection of the car, be higher than five hundred (500)mm from ground level. *Refer ART 34.*

47.2.3 Transmission / Drive Line

- Drive 2x4 or 4x4.
- The gearbox, differentials, propshaft and installation shall be the standard OEM units from the applicable vehicle, mounted in the standard OEM position. Mountings may be reinforced. The driveshafts are free, but must be steel, and must fit into the standard driveline without any modifications to the rest of the driveline.
- The CVT belts are free but must be commercially available from a dealer catalogue. The ratio shift parameters may be modified. Clutch discs may be upgraded with parts from a series vehicle or from a catalogue of commercially available competition parts. Additional cooling air to the CVT may be provided.

47.2.4 Braking system

The braking system is free, provided that:

- it is activated and controlled only by the driver.
- it includes at least two (2) independent circuits operated by the same pedal. Between the brake pedal and the callipers, the two (2) circuits must be separately identifiable, without any interconnection other than the

mechanical braking force balancing device, which may be a balance bar or the OEM tandem dual piston master cylinder.

- the pressure is identical on the wheels of the same axle.
- the callipers must come from a series vehicle or from a catalogue of commercially available competition parts with a maximum of four (4) pistons.
- the discs must come from a series vehicle or from a catalogue of commercially available competition parts. The maximum diameter may not exceed three hundred and thirty (330)mm.
- if standard vehicle is fitted with hand brake it should stay, as well as actuation system, without modification.

47.2.5 Electrical System

The electrical system is free provided it complies with the safety standards as required in the road ordinance and *ART 38.*

47.2.6 Suspension and steering

- The suspension stroke at the wheel centre is limited at 560mm (front) and at 610mm (rear).
- The suspension arms are free but must fit in the standard chassis mounting points without any modifications and must be the same length from pivot point to pivot point, i.e., no geometry changes.
- Uprights, wheel bearings and hubs must be OEM from the standard vehicle, or from a catalogue of commercially available competition parts. Suspension pivot points must remain in the OEM standard position.
- The original OEM dampers must be retained but valving may be changed. Only different size shims and number will be allowed.
- Suspension springs are free. Only one (1) damper and spring per wheel is allowed.
- All the suspension mounting points on the chassis must remain in the standard position but may be reinforced.
- The adjustment of the springs and/or dampers from the cockpit is forbidden. It must only be possible when the car is stationary and only with the use of tools. The damper adjustment device must be situated on the damper or its gas reservoir.
- Any connections between dampers are forbidden. Closed loop control systems – electric, pneumatic, or hydraulic that result in interconnecting front to rear or left to right, or adjust spring and damping parameters, or

adjust ride height on the move, are not allowed.

- Steering gearbox standard, or from a catalogue of commercially available competition parts, but must bolt on to the chassis in the standard position. The power-steering OEM principle must stay standard as well as the mechanism.
- Only one (1) antiroll bar per axle is permitted. The adjustment of the antiroll bars from the cockpit is forbidden. The antiroll bar system must be exclusively mechanical, with no activation or deactivation possible. Any connections between front and rear antiroll bars are forbidden. The diameter of the antiroll bars is free. Anti-roll bars may be removed.

47.2.7 Wheels and tyres

- The maximum rim diameter is 15inches, the maximum inflated tire diameter is 30inches (770mm). (*FIA App J 286 and 286A art 11*)
- The wheels do not have to be of the same diameter. Motorcycles wheels are not allowed.
- Rims may be made out of aluminium or steel. Wheel spacers are not allowed. Central wheel nuts are not allowed.
- The use of any system on board for inflating / deflating the tires when the car is in motion is not allowed.
- The vehicle must be able to carry two (2) full-sized spare wheels but may race with one only. Position of spare wheels is free but must have sturdy mountings.

47.2.8 Chassis

- Standard production chassis of the vehicle is to be retained.
- Chassis may be reinforced, but no part of the original chassis rails and cross members may be removed from the floor structure.
- Mounting points for roll cage, fuel tanks and other items may be added.
- Roll cage shall be fitted to comply as a minimum with *GCR 239*.
- Seats and safety harnesses shall be fitted to comply with *ART 39 & 40*.
- A sturdy protection must be fitted over the front propshaft under the floor in the tunnel to protect the feet and legs of Driver and Navigator in the event of propshaft failure or crash. A steel tube, diameter larger than the propshaft, wall thickness 2,5mm minimum, can be cut in half along the centreline and attached to the chassis tubes front and rear. Front attachment at the front carrier bearing and

rear attachment at the rear carrier bearing or a chassis tube behind the seat backs. Alternatively, rings fabricated out of 30x5 steel flat bar can be used. Cut the rings in half and add ears to bolt the two halves together.

- Attach the front ring at just behind the front carrier bearing and the rear ring to the chassis behind the seat backs. The two (2) universal joints must be outside the protection. Only the propshaft tube inside.
- Split the rings to fit the propshaft. Refer also *FIA App J Art 286.5.13*

47.2.9 Body

- Standard production body of the vehicle is to be retained. Cut-outs may be made to fit the safety cage and allowed modifications. No aerodynamic aids will be allowed unless it is fitted as standard on the showroom floor of the specific model.

47.2.10 Fuel system

- The fuel system shall retain the standard basic layout of the production vehicle but may be modified whilst complying with *GCR 257*.
- Two (2) additional fuel tanks may be fitted to increase the fuel capacity to 130litre maximum, which should allow 175 race km's without refuelling.
 - a) The additional fuel tanks shall be fitted under the two (2) seats, each fitted with a lift pump to feed fuel separately to the standard Can-Am fuel tank. The lift pumps shall be regulated to switch off when the standard tank is full to prevent overflowing through the breather. The lift pumps shall be connected via the ignition switch, each with its own switch, fuse, and relay.
 - b) The fuel tanks to be fabricated using three (3)mm thick 5000 or 6000 series aluminium. Welding to be done by a certified aluminium welder.
 - c) The fuel tanks shall be mounted with the lowest part of the tank not lower than ten (10)mm from the underside of the chassis tubes. The fuel tanks must have a minimum of ten (10)mm clearance between tank and any part of the chassis surrounding it. Cars with fuel tanks not complying will have to be modified.
 - d) The tanks shall be properly tied down by two (2) 50mm x2mm steel straps with two (2) M8 x 8.8 bolts each side of the strap. The tanks may alternatively be mounted by weld-on brackets if steel strap mounting is not

- feasible. At least four (4) mounting brackets are required, using M8 x 8.8 bolts. Rubber bushes may be mounted in-between to absorb vibration and chassis flexing.
- e) The complete area underneath the tanks from the pedal box to the rear of the tanks and full width to be covered by three (3)mm Hardox 450 steel sheet (www.ssab.co.za) or equivalent. The protection plates to be bolted by M8 x 8.8 bolts suitably spaced. Drain holes to be made in the four (4) corners of the plate to allow spilt fuel to drain from the floor. The standard Can-Am heavy duty ten (10)mm thick composite floor protection plate may also be used, unmodified. The area between the tank and the floor plate must be completely filled with a sheet of Sondor closed cell Neoprene 25. The fuel tank may not be in direct contact with the floor plate or chassis anywhere at any time.
- f) The fuel filler/s must be inside the safety cage envelope, not to be touched by the ground surface when the vehicle is lying on its side. The filler/s must be as far away as possible from the crew, and also not near the engine. There may be no holes in the filler caps and the cap seals must be fuel tight.
- g) The fuel tank breather/s, including the standard plastic tank to be routed from the top of the highest fuel tank to under the roof, across to the opposite side of the car, and then down to below the bottom of the lowest tank. All the way inside the safety cage for protection.
- h) The filling of tanks with a fire-retardant agent, e.g., ATL SF 103 or similar, will be encouraged.
- i) Only braided steel hoses with matching screw fittings will be allowed to convey fuel and oil through the passenger compartment. Hose clamp fittings will not be allowed. All fuel hoses to be properly tied in place to prevent pinching and chafing.
- j) The standard unmodified Can-Am bulkhead engine cover, fastened, including all inspection covers, as per Can-Am service instructions, shall at all times be fitted in the crew compartment behind the seats to provide engine compartment fire protection for the crew. No additional air inlet duct or inspection hatches will be allowed.
- k) The fuel tanks and ancillaries shall be mounted securely in terms of safety to the satisfaction of the Controllers
- 47.2.11 Auxiliaries**
- All vehicles shall be fitted with a GPS and committee approved tracking device in its entirety. *Refer ART 2.8*
 - All vehicles shall display competition numbers complying with *the ART 3.4 and ART 47.1.9.*
 - All vehicles shall carry emergency equipment as per *ART 2.6 & 2.7* to the satisfaction of the Medical Officer.
 - All vehicles shall have window nets, mirrors, and cutters to comply with *ART 35.2* to the satisfaction of the Controllers.
 - All vehicles shall have batteries, lighting and electrical to comply with *ART 38* to the satisfaction of the Controllers.
 - Fire extinguishers: *Refer ART 36.* Only the equipment as specified will be acceptable.
- 47.3 Vehicle technical Regulations: Class side by side (SXS)-FIA**
- 47.3.1** Vehicles that conform entirely to *FIA App J Art 286 Specific Regulations for Lightweight Prototype Cross Country Vehicles (Group T3)*, all applicable FIA Regulations, prescriptions, and Bulletins, including General Prescriptions as amended by FIA.
- 47.3.2** Vehicles that conform entirely to *FIA App J Art 286A Specific Regulations for Lightweight Series Production Cross-Country Side-by-Side Vehicles (Group T4)* all applicable FIA Regulations, prescriptions, and bulletins, including General Prescriptions as amended by FIA.
- 47.3.3** The Controllers retain the right to apply balance of performance measures should conditions require. *Refer 47.1.5.*

48. PRODUCTION & FIA VEHICLE CATEGORIES AND CLASSES

NOTES:

48.1 Competitors contemplating the purchase or construction of a new vehicle for any of the Classes must ensure that the specifications and design is acceptable to the Controllers and acceptance has

been confirmed in writing and signed by the Committee. *Refer Art 31.4, 31.5, 31.6 & 31.7.*

48.2 For safety reasons crews must consist of two (2) persons to compete in the Series.

GENERAL REGULATIONS – ALL PRODUCTION & FIA VEHICLE CATEGORY VEHICLES

49.1 Any form of aerodynamic device or variation in body shape that may be construed as an aerodynamic device to provide extra down force or decrease drag is not allowed.

49.2 Skid plates may be added to protect steering, suspension, engine, transmission, diff housings and fuel tanks. These skid plates may only be made of steel, aluminium alloy, or composite. *Refer ART 49.8.2.*

49.3 Additional fluid coolers may be added for engine oil, transmission oil, differential oil, and power steering fluid.

49.4 Mud flaps fitted to competing vehicles may be fitted behind the front and/or rear wheels only, may not be wider than 40cm and must be more than 100mm above the ground stationary, ready to race.

49.5 Bush deflector bars or cables may be added between the front fenders and the cab roof.

49.6 Side protection bars may be added provided they do not protrude past the overall width of the vehicle.

49.7 Vehicles must be fitted with sturdy towing eyes front and rear, in a visible and accessible position, painted red or orange.

49.8 49.8.1 Titanium or magnesium materials are not allowed, unless they are fitted as standard parts on the homologated production vehicle.

49.8.2 Carbon fibre and Kevlar materials are not allowed other than for specific aesthetic use only, e.g., one layer for dashboard panels, air cleaner assemblies, air ducts, inner door closure panels, selected body panels. Multi layers of Kevlar may be used for genuine stone protection areas.

49.9 No traction-, launch- or vector control, ABS, electronically controlled active suspension, or any closed-loop electronic control system whatsoever, except engine management, may be used. No pneumatic or hydraulic suspension allowed, only mechanical. Steering must be direct mechanical

with hydraulic or electrical assistance.

49.10 Air cleaner system free and position free. Should air be passed through the passenger compartment only a pipe with a maximum diameter of 110mm may be used. Restrictors must be in the engine compartment. *Refer ART 33.2*

49.11 An on-board tyre “deflation/inflation system” may only be used in FIA Category for 4X2-T1.2.

49.12 An on-board vehicle jacking system may only be used in Category FIA.

49.13 Telemetry is not permitted, but on-board data logging is allowed.

49.14 Fasteners used throughout the vehicle are free and production fasteners may be replaced by alternatives. Ferrous materials only.

49.15 On-board fire protection system is recommended for all vehicles competing in this Class. *Refer ART 36.*

49.16 The use of electronic devices for communication (two-way radios/cell phones/intercoms) purposes are allowed. Only GPS equipment specified in *ART 2.8* will be allowed for route finding.

49.17 The vehicle shall be constructed to accommodate a crew of two (2).

49.18 Tyres

- Tyres for Class T must be from the Committee Approved list, but the number is free.

- Tyres for FIA - *refer art 43.2.*

- Tyres for all other Classes refer to the specific Class Regulations.

- Only commercially available tyres may be used in Classes S, D, E and F with a maximum size of 235/85r16.

- Class D and E may still make use of used “Old Style” BF Goodrich / Michelin race tyres. Use of the “New Style” BF Goodrich race tyre is reserved for use by vehicles in the FIA Category only.

49.19 The use of well-designed and manufactured steering multipliers is allowed on any off-road racing vehicle.

49.20 Re-engined vehicles with engines complying to ART 32.3 will be allowed with the written permission of the Controllers.

49.21 All spare wheels must be securely fastened when on the vehicle.

49.22 Windscreens

- A standard production homologated safety glass windscreen must be used.
- It must be possible to remove the side windows or doors without tools, to allow the crew to escape in an emergency. Driver and Navigator must be able to exit the vehicle unaided within seven (7) seconds on either side of the vehicle.
- All other glass may be replaced with

polycarbonate material, Lexan F2000 sheet or equivalent, min thickness three (3)mm. Refer ART 35.

49.23 Fuel Refer ART 32.10

Fuel tanks must have sufficient capacity to complete 175 kilometres of racing. Refer ART 18.1

49.24 Speed limits:

The maximum speed may not be exceeded. Exceeding the speed limit as indicated on the GPS track will be penalised. Refer Part I, Refer ART 5.4 & 20.1.1 (h).

50. FIA VEHICLE CATEGORY

NOTES:

50.1 Competitors contemplating the purchase or construction of a new vehicle for any of the Classes must ensure that the specifications and design is acceptable to the SA Rally-Raid Championship and acceptance has been confirmed in writing and signed by both the CEO and the Technical Delegate. Refer Arts 31.4 and 31.7.

50.2 For safety reasons crews must consist of two (2) persons to compete in National Championship Events.

50.3 Class Summary

Class	Typical Car	Engine	Restrictor	Weight	Notes
FIA Class: Big Wheel 37" Wheel	Hilux 4x4	3,5 l V6 T	37 mm	Weight as per FIA 285: 2010 kg	Maximum speed 170km/h
	Ranger 4x4 Century CR7 4x4	3,5 l V6 T 2,9 l V6 T			
	Revo 4x4	3,8 l V6 T			
	Century CR6 4x2	2,9 l V6 T			
	Hilux 4x4	5 l V8 4v NA	39 mm	Weight as per FIA 285: 2010 kg	Maximum speed 170km/h
	Ranger 4x4	5 l V8 4v NA	39 mm		
	Revo 4x4	5,6 l V8 4v NA	39 mm		
	Century CR6 4x2	7 l pushrod V8 NA	40mm		
FIA Class: Small Wheel 32" Wheel	Hilux 4x4	5 l V8 4v NA	38 mm	Weight as per FIA 285: 1850 kg	Maximum speed 170km/h
	Ranger 4x4	5 l V8 4v NA			
	Revo T1 4x4	5,6 l V8 4v NA			
	Red-Lined 4x4	5,6 l* & 5,0 l** V8 4v NA			

NOTE: * The VK 56 has dispensation to run with 1850kg instead of 1925kg since 2022. Remains like that.

** The VK 50 has dispensation to run with a 39mm restrictor.

50.4 FIA Big Wheel Class

50.4.1 This Class will conform to **FIA Group Ultimate which includes Classes T1+ and T1.2+**

50.4.2 In **Classes FIA T1+ and T1.2+** the *FIA Regulations App J, articles 281, 282, 283, 285 and all Sporting Regulations take precedence*, unless an MSA Bulletin specifies a different requirement to replace the FIA Regulation.

50.4.3 Penalties for non-conformance to Regulations will be applied as per *GCR 176*.

50.4.4 Cars entered in the FIA Big Wheel Class must have FIA certified Safety Cage documents. If the car will only be entered in Off-Road North series events, the FIA sticker will not be necessary.

50.4.5 An FIA Technical Passport will not be necessary, but a series issued Technical Passport must be completed and maintained.

50.5 FIA Small Wheel Class

50.5.1 This Category will conform to **FIA Class T1.1** the *FIA Regulations App J, articles 281, 282, 283, 285 and all Sporting Regulations take precedence*, unless a MSA Bulletin specifies a different requirement to replace the FIA Regulation.

50.5.2 Penalties for non-conformance to Regulations will be applied as per *GCR 176*.

50.5.3 Cars entered in the FIA Class must have FIA certified Safety Cage documents. If the car will only be entered in Off-Road North series events, the FIA sticker will not be necessary.

50.5.4 An FIA Technical Passport will not be necessary, but a series issued Technical Passport must be completed and maintained.

50.5.5 The Nissan T1.1 vehicles will be allowed to run the VK56 5600cc engine with **1850kg** minimum weight, and the VK50 engine will be allowed to use a 38mm restrictor.

51. CLASS T | PRODUCTION VEHICLES, 5 LITRES – FOUR WHEEL DRIVE

51.1 Engines:

51.1.1 All Class T Vehicles must be fitted with Group N specification engines only.

- Normally aspirated (NA) petrol engines, capacity not exceeding 5020cc.
- All normally aspirated engines must retain the original inlet manifolds and throttle bodies as per Group N specification.
- The inlet manifolds must remain unmodified. The addition of a spacer, maximum thickness 70mm, between the inlet manifold and the cylinder head is allowed. All unused apertures must be sealed completely.
- No breather systems allowed in between the restrictor and the cylinder head.
- Electronic throttle bodies may be converted to mechanical actuation and vice versa, but the air passage and butterfly valve sizes must remain original.

51.1.2 Exhaust systems are free, but must be made from steel, and conform to *ART 34*.

51.1.3 Engine position. The intersection of the front face of the cylinder block and the crankshaft centreline must be more than 100mm forward of the front axle centreline. Engine height to be governed by the Committee Approved front differential housing mounted generally on the front axle centreline, and the engine mounted

over this differential. *See Addendum 3*.

51.1.4 Modifications allowed to external engine ancillaries:

- Exhaust manifolds for normally aspirated engines and exhaust systems are free but must be made from ferrous material. *Refer ART 34*.
- Flywheel to be original, or made of ferrous material only, otherwise free.
- Engine mountings free. The attachment of the mountings to the engine block must be to the standard position.
- Engine management system free. The use of a gear cut system (engine cut to aid gear change) is authorised. *Refer ART 49.9*.
- All unused external bolt-on ancillaries may be removed from the engine e.g., air conditioner pumps, heater pipes, etc.

51.1.5 Power steering pumps and alternator as well as their brackets/mountings free.

51.2 Transmission/Driveline:

51.1.1 General:

- Only 4X4 drivelines are allowed. Mechanical drive only. No electric, hydraulic, pneumatic drives allowed.
- Hydraulic torque converters allowed.

51.1.2 Gearbox

- Free from the marque with production ratio's only, or

- Committee Approved gearbox. *Refer C.A. list.* Ratios are free.

51.13 Transfer gearbox (4WD)

- Free from the marque with internals free, or
- Committee Approved transfer gearbox. *Refer C.A. list.*

51.1.4 Clutch

- Twin plate clutches may be used; no carbon components are allowed.

51.1.5 Front Axle/Differential assembly (4WD)

- Original units may be retained, internal components free, or
- Committee Approved front axle/differential assembly.

51.1.6 Rear Axle/Differential assembly

- Original units may be retained, internal components free, or
- Committee Approved beam rear axle/differential assembly. Ratio free.

51.1.7 Prop shafts

Free, ferrous material only.

51.1.8 Constant Velocity Joints (CV)

- Original CV joints, or
- outer and inner CV joints Committee Approved.

51.1.9 Driveshafts

- Free, ferrous material only.

51.3 Brake System

51.3.1- Original brake system may be used in its entirety, or

- A racing pedal box system is authorised. The front-rear brake force balance may only be changed manually via a cable connected to the "balance bar" in the pedal box, turned by hand by the driver or navigator.
- No ABS or similar electronic control systems allowed.

51.3.2 The original hand brake system may be removed.

The fitting of a hydraulic hand brake system is authorised.

51.3.3 Front disc - original equipment, or Committee Approved production based.

51.3.4 Front brake calliper - original equipment, or Committee Approved production based.

51.3.5 Rear disc - original equipment, or Committee Approved production based.

51.3.6 Rear brake calliper - original equipment, or Committee Approved production based.

51.3.7 Friction material – free. No carbon discs.

51.3.8 Equal hydraulic pressure on the same axle a requirement.

51.3.9 No water-cooling systems for brakes allowed.

51.4 **Suspension**

Refer addendum 1, 2 & 3.

51.4.1 General:

- Closed loop control systems – electric, pneumatic, or hydraulic that result in interconnecting front to rear or left to right, or adjust spring and damping parameters, or adjust ride height, are not allowed.
- No adjustments may be made from the crew cab. Only adjustments allowed will be directly on the suspension with the vehicle stationary.
- Suspension travel limited to 250mm for independent suspension, measured at the wheel centre, or 300mm for beam axle measured at the wheel centre with axle horizontal. *Refer ART 32.6.*
- The wheelbase for all vehicles competing in the Class will be 2975mm, ± 100mm. The x-position of the front axle is free, respecting *ART 51.7 & Addendum 2* and the minimum Reference ground clearance of 300mm under sump guards. The x - position of the rear axle is determined by the wheelbase and the position of the front axle.
- The track may be increased so as to fit inside the two (2)-metre-wide bodywork.
- Suspension bush medium – free, including ball joints, Uniball/'rose' joints.
- The springs and dampers must act directly on either the suspension control arm, axle, or upright/knuckle.
- No rocker systems will be allowed.

51.4.2 Springs

- Suspension springs are free, respecting *ART 51.4.1.*

51.4.3 Suspension dampers

- Must be stand-alone mechanical/hydraulic/gas damper only.
- Valving is free.
- Number and location are free.

51.4.4 Anti-roll bars

- Only one anti-roll bar per axle is permitted.
- The adjustment of the anti-roll bars from the cockpit is forbidden.
- The anti-roll bar systems must be exclusively mechanical, with no activation or de-activation possible from the crew compartment, or with the vehicle moving.
- Any connections between front and rear anti-roll bars are forbidden.

51.4.5 Suspension knuckle/upright

- Original or Committee Approved. If Committee Approved, the suspension knuckle/upright and wheel bearing/hub assemblies must be interchangeable left to right, bolt-on brackets excluded.

51.4.6 Control Arms, front

- The lateral distance between the left and right lower control arm mounting points may not be less than 550mm measured horizontally from left rotation centre to right rotation centre. The longitudinal and vertical position is free, respecting Addendum 2.
- The lateral distance between the left and right upper control arm mounting points may not be less than the actual lateral distance between the lower control arms as measured between rotation centres. The longitudinal and vertical position is free.
- Control arms may be manufactured from ferrous material only, otherwise free.

51.4.7 Suspension - rear

a) Live Rear Axle

All Class T vehicles must be converted to a live rear axle system, regardless of the original arrangement fitted to the vehicle selected. Live rear axles must be modified to a four (4)-link system with coil springs and telescopic dampers. The upper arms of the system shall be A-arm type only. The upper A-arm and lower arms are of free design, but ferrous materials only may be used. The only area that this suspension system may occupy is 1.2metre ahead of the new rear axle centre line and 250mm behind the new axle centre line and one metre above the ground at the specified ride height of 300mm.



51.5 **Steering**

- The original steering system may be used.
- A Committee Approved steering system may be used.
- On all units, the rack and tube may be shortened.
- Track rods, steering arms and joints are free.

- If the steering column shaft used is not a standard production unit, a design verification for the component used must be produced with the vehicle for first scrutineering. Ample provision must be made for allowing the column and shaft to telescope or deflect away from the driver in the event of a frontal impact.

51.6 **Wheels, Rims and Tyres**

51.6.1 The use of magnesium wheels is not permitted. Steel or aluminium are the only materials authorised.

51.6.2 The Committee reserves the option to specify a control tyre by make type and size.

51.6.3 Maximum tyre diameter is 810mm.

Maximum tyre size is 235/85R16.

51.7 **Body and Chassis**

Refer Addenda 1, 2 & 3 and Art 31.5.

51.7.1 **The chassis must either:**

- Derive from a chassis (or monocoque body) of a car produced in a quantity greater than 1000 per year (*FIA or MSA approval required*). In this case, the chassis/monocoque may only be modified in accordance with all the requirements in Part III: Classification and Vehicle Specifications, or
 - Be a steel tubular frame chassis incorporated in the safety cage in accordance with *ART 39, 40 & 41*.

51.7.2 The body of the vehicle must be from the model range of the make of vehicle specified in the Technical Passport.

- The standard body profile side view proportions from the front of the grille, bonnet, and fenders to the rear of the crew cab and to the rear of the load body must be retained.
- The same applies to the plan view, front view, and rear view.
- The modifications are allowed in the spirit of retaining the production vehicle appearance, i.e., the standard body profile proportions must be retained.

a) The standard windscreen aperture and rake must be maintained.

b) The standard headlights and radiator grille to be retained and mounted in standard lay-out.

c) The horizontal distance from the base of the windscreen to the front edge of the bonnet, may not exceed the standard vehicle dimension. To be measured on the vehicle centreline, with the sills set level.

- d) The vertical distance between the base of the windscreen and the horizontal centre of the headlight/grille assembly may not be less than the standard vehicle dimension. To be measured on the vehicle centreline, with the sills set level.
 - e) The front and rear overhang dimensions are 660mm minimum and has to be maintained over a minimum lateral distance of 500mm around the centreline of the vehicle (250mm each side). The front and rear departure angles are free.
 - f) The front bumper, bonnet and fenders may be modified *respecting a), b), c), d) and e)*, and must blend in with the windscreen, headlights, and grille in their original orientation to maintain the production vehicle appearance in standard body proportions.
 - g) The three (side-, plan-, rear-) profiles of the cab and load body must reflect the profile proportions of the production vehicle.
 - h) The width and height of the crew cab may be increased from standard to comply with the FIA Regulations with the specific written permission of the Controllers.
 - i) The crew cab may be original steel modified or remanufactured in fiberglass composite with one covering layer of Carbon Fibre only for aesthetic purposes. *Refer ART 43.3.2.*
The front doors must remain in the original production material or may be made of composite material but must be of the original shape and size and be fitted to the racing vehicle using the original steel hinges with all the steel bolts in their original positions bolted onto the steel chassis frame. The original door locks must be retained, opening from inside and outside. Window winding mechanisms may be removed, *respecting ART 49.22.*
 - j) The doors must still provide sufficient protection for the occupants in the case of an accident. Should the space below the floor of the crew cab be utilised for components and storage, the sills may be extended from the floor level downwards and laterally not wider than the maximum vehicle width of 2000mm blending into the wheel arch extensions.
 - k) The standard doors may be shortened at the bottom by up to 200mm, to accommodate the larger cab sills, *respecting paragraph j)* and remaking the bottom portion of the door frame in steel.
 - l) All window openings other than the cab rear window must be retained in their original position and be of the original size and shape. These windows other than the front door windows may be transparent, open, or opaque. *Refer ART 49.22.*
- 51.7.3 The maximum width of the vehicle is two (2) metres, excluding the rear-view mirrors. The wheel arches and the cab sills may be extended to this maximum of two (2)-metre overall width by the use of fender flares and laterally extended sills. The wheel arches may be repositioned to accommodate the wheelbase and overhang specified. Seen in vertical projection, the body work must cover at least 120° of the upper circumference of the wheels situated above the wheel axis as viewed from the side. This width measurement must be checked with the ride height set at 300mm measured at the front under the sump guard, and the sills level. *Refer Addendum 1.*
- 51.7.4 Two (2) air vents or two (2) bulges to accommodate approved under-bonnet modifications, may be added to the bonnet of a racing vehicle, however, these may not protrude more than 50mm above the modified base profile of the bonnet.
- 51.7.5 Air ducting to rear mounted water radiators may be fitted on the passenger cabin roof but should follow the roof line to maintain the profile of the cabin. These additions are subject to the specific approval of the Controllers in writing through the TC.
- 51.7.6 Vents or scoops may be added to the cabin roof for the purpose of providing ventilation for the Driver and Navigator. These vents must be blended to fit the roof profile.
- 51.7.7 The original body work sheet metal and hardware, onto which the headlights, radiator, and grille is mounted, may be removed, and replaced with a fabricated structure designed to perform the same function, providing none of the other provisions in these Regulations are contravened and the finished vehicle retains its original outward appearance.

- 51.7.8 The firewall between the engine compartment and the passenger compartment, along with the floor of the passenger compartment and the tunnel, which forms part of the floor, may be removed, and refabricated in order to accommodate authorised non-standard components, respecting Articles 39 Safety Belts and 40 Seats and Seat mountings, and providing none of the other provisions in these Regulations are contravened and the finished vehicle retains its original outward appearance. The new tunnel, floor and firewall may be fabricated from steel or composite. A single layer of carbon will be allowed on the top side of the tunnel, floor, and firewall for aesthetic purposes. The TC / Chief Scrutineer reserves the right to drill a 30mm hole with a hole saw in a place of his discretion to analyse the composition of the components. *Refer ART 43.3.1 & 43.3.2.*
- 51.7.9 The production dashboard may be retained or remade in a similar shape and size in an alternative material which is non-metallic. All other trim should be removed. *Refer ART 43.3.1.*
- 51.7.10 Competitors intending to convert station wagons, SUV's, panel vans etc. must obtain the prior approval of the Controllers through the Technical Consultant and be briefed on the Committee's specific interpretation of the Class T Rules and how they will apply to such vehicles.
- 51.7.11 The floor pan behind the crew may be cut and modified or remade to accommodate the fuel tank. The fuel tank and fuel lines must be separated from the cockpit by a liquid and fireproof bulkhead. *Refer ART 37*
- 51.8 **Fuel System** - *Refer ART 37.*
- 51.8.1 The fuel tank size is free.
- 51.8.2 Fuel feed pumps are free.
- 51.8.3 Fuel coolers of the air to fuel type are authorised in the return lines.
- 51.9 **Electrical System**
- 51.9.1 Battery size, type, and location – free. *Refer ART 38.*
- 51.9.2 Wiring harness - free.
- 51.9.3 Lights - *Refer ART 38.*
- 51.10 **Cooling System**
- 51.10.1 The engine cooling water radiator/s and position is free. The addition of electric water pumps to aid water cooling and the addition of ducting components to improve airflow through the radiator is authorised.
- 51.10.2 Transmission coolers – free.
- 51.10.3 Power Steering coolers – free.
- 51.10.4 All coolers must be housed within the standard bodywork profiles. Minimal cutting of internal bodywork only is allowed to accommodate the fitting of these systems.

52. CLASS S | PRODUCTION VEHICLES, 4 LITRES – FOUR WHEEL DRIVE

52.1 **General:**

52.1.1 Competitors with older vehicles not conforming completely to Class S Rules, may apply to the Committee to enter. Entry will be allowed subject to performance limitation or enhancing controls, such as weight, restrictor, and engine, body, suspension, and chassis deviations. Acceptance must be confirmed in writing and signed by both the Controllers and the TC. *Refer ART 31.4, 31.5, & 31.6.*

52.1.2 For Class S only, the minimum mass as specified in *ART 33.1* will remain as in 2014, which is 60kg higher. *Refer ART 33.1*

52.2 **Engines**

52.2.1 All Class S Vehicles must be fitted with Group N specification engines only.

- Normally aspirated (NA) petrol engines, capacity not exceeding 4000cc.
- Engines with a throttle valve per cylinder will not be allowed.

52.2.2 An alternative engine may be selected from the same Marque (make, i.e., Nissan, Ford) of Production Vehicle, Commercial Vehicle, Bakkie, or Passenger Car.

52.2.3 Engine position

- The intersection of the front face of the cylinder block and the crankshaft centreline must be more than 100mm forward of the front axle centreline.
- Engine height to be governed by the Committee Approved front differential housing mounted generally on the front axle centreline, and the engine mounted over this differential. *Addendum 3.*

52.2.4 For normally aspirated engines:

- The intake manifold must be original or originate from the engine of a series vehicle in the marque.

- The addition of a spacer, maximum thickness 70mm, between the manifold and the cylinder head is the only modification permitted for adjustment.
 - The manifolds must remain unmodified. All unused apertures must be sealed completely. No breather systems allowed in-between the restrictor and the cylinder head.
 - Electronic throttle bodies may be converted to mechanical actuation and vice versa, but the air passage and butterfly valve sizes must remain original.
- 52.2.5A two percent (2%) capacity increase will be allowed for re-boring the cylinders. Written approval to be obtained from the Controllers.
- 52.2.6 Modifications allowed to external engine ancillaries:
- Exhaust manifolds and exhaust systems are free but must be made from ferrous material. *Refer Art 34.*
 - Flywheel to be original, or made of ferrous material only, otherwise free.
 - Engine mountings free. The attachment of the mounts to the engine block must be to the standard position.
 - Engine management system free. The use of a gear cut system (engine cut to aid gear change) is authorised. Refer ART 43.4
 - All unused external bolt-on ancillaries may be removed from the engine e.g., air conditioner pumps, heater pipes etc.
 - Power steering pumps and alternator as well as their brackets/mountings free.
- 52.3 Transmission/Driveline**
- 52.3.1 Gearbox**
- Only 4x4 drivelines are allowed.
 - Mechanical drive only.
 - No electric, hydraulic, pneumatic drives allowed.
 - Hydraulic torque converters allowed.
 - free from the marque with production ratio's only, or
 - Committee Approved gearbox. Refer C.A. list.
 - Ratios are free.
- 52.3.2 Transfer gearbox**
- free from the marque with internals free, or
 - Committee Approved transfer gearbox. *Refer C.A. list.*
- 52.3.3 Twin plate clutches may be used; no carbon components are allowed.
- 52.3.4 Front Axle/Differential assembly**
- original units may be retained, internal components free, or
 - Committee Approved front axle/differential assembly.
- 52.3.5 Rear Axle/Differential assembly**
- original units may be retained, internal components free, or
 - Committee Approved rear axle/differential assembly.
- 52.3.6 Prop shafts**
- Free – ferrous material only.
- 52.3.7 Constant Velocity Joints (CV)**
- Original CV joints, or
 - outer and inner CV joints Committee Approved.
- 52.3.8 Drive shafts**
- Free, ferrous material only.
- 52.4 Brake System**
- 52.4.1 Original brake system may be used in its entirety, or
- 52.4.2 A racing pedal box system is authorised. The front-rear brake force balance may only be changed manually via a cable connected to the “balance bar” in the pedal box, turned by hand by the driver or navigator. No ABS or similar electronic control systems allowed.
- 52.4.3 The original hand brake system may be removed. The fitting of a hydraulic hand brake system is authorised.
- 52.4.4 Front disc - original equipment, or Committee Approved production based.
- 52.4.5 Front brake calliper - original equipment, or Committee Approved production based.
- 52.4.6 Rear disc - original equipment, or Com Committee mission Approved production based.
- 52.4.7 Rear brake calliper - original equipment, or Committee Approved production base.
- 52.4.8 Friction material – free. No carbon discs.
- 52.4.9 Equal hydraulic pressure on the same axle a requirement.
- 52.4.10 No water-cooling systems for brakes allowed.
- 52.5 Suspension**
- Refer addenda 1, 2, 3.*
- 52.5.1 General**
- Closed loop control systems – electric, pneumatic, or hydraulic that result in interconnecting front to rear or left to right or adjust spring and damping parameters, or adjust ride height, are not allowed.

- No adjustments may be made from the crew cab. Only adjustments allowed will be directly on the suspension with the vehicle stationary.
- Suspension travel limited to 250mm for independent suspension, measured at the wheel centre, or
- 300mm for beam axle measured at the wheel centre with axle horizontal. *Refer Art 32.6.*
- The wheelbase for all vehicles competing in the Class will be 2975mm, ± 100 mm. The x-position of the front axle is free, respecting Art 43.4.8, Addendum 2 and the minimum Reference ground clearance of 300mm under sump guards.
- The x-position of the rear axle is determined by the wheelbase and the position of the front axle.
- The track may be increased so as to fit inside the two (2)-metre-wide bodywork.
- Suspension bush medium – free, including ball joints, Uniball/'rose' joints.
- The springs and dampers must act directly on the suspension control arm, axle, or upright/knuckle. No rocker systems will be allowed.

52.5.2 Springs

- Suspension springs are free, respecting *ART 52.5.1.*

52.5.3 Suspension dampers

- Must be stand-alone mechanical/hydraulic/gas damper only.
- Valving is free.
- Number and location is free.
- Dampers for Class S must be Committee Approved and recorded in the Technical Passport of the vehicle.

52.5.4 Anti-roll bars

- Only one anti-roll bar per axle is permitted.
- The adjustment of the anti-roll bars from the cockpit is forbidden.
- The anti-roll bar systems must be exclusively mechanical, with no activation or deactivation possible from the crew compartment, or with the vehicle moving.
- Any connections between front and rear anti-roll bars are forbidden.

52.5.5 Suspension knuckle/upright

- Original or Committee Approved.
- If Committee Approved, the suspension knuckle/upright and wheel bearing/hub assemblies to be interchangeable left to right, bolt-on brackets excluded.

52.5.6 Control Arms

- The lateral distance between the left and right lower control arm mounting points may not be less than 550mm measured horizontally from left rotation centre to right rotation centre. The longitudinal and vertical position is free, respecting *ART 53.6 & Addendum 2.*
- The lateral distance between the left and right upper control arm mounting points may not be less than the actual lateral distance between the lower control arms as measured between rotation centres. The longitudinal and vertical position is free.
- Control arms may be original equipment, or manufactured from ferrous material only, otherwise free.

52.5.7 Suspension - rear

Live Rear Axle - All Class S vehicles must be converted to a live rear axle system, regardless of the original arrangement fitted to the vehicle selected. Independent rear suspension will not be allowed. Live rear axles must be modified to a four (4)-link system with coil springs and telescopic dampers. The upper arms of the system shall be A-arm type only. The upper A-arm and lower arms are of free design, but ferrous materials only may be used. The only area that this suspension system may occupy is 1.2metre ahead of the new rear axle centre line and 250mm behind the new axle centre line and one metre above the ground at the specified ride height of 300mm.



52.6 **Steering**

- The original steering system may be used.
- A Committee Approved steering system may be used.
- On all units, the rack and tube may be shortened.
- Track rods, steering arms and joints are free.

- If the steering column shaft used is not a standard production unit, a design verification for the component used must be produced with the vehicle for first scrutineering. Ample provision must be made for allowing the column and shaft to telescope or deflect away from the driver in the event of a frontal impact.

52.7 Wheels, Rims and Tyres

52.7.1 The use of magnesium wheels is not permitted.

Steel or aluminium is the only materials authorised.

52.7.2 The Committee reserves the option to specify a control tyre by make type and size.

52.7.3 Maximum tyre diameter is 810mm. Maximum tyre size is 235/85R16.

52.7.4 Tyres must be commercially available.

52.8 Body and Chassis

ART 31.5 & Addenda 1, 2 & 3

The chassis must either:

- derive from a chassis (or monocoque body) of a car produced in a quantity greater than 1000 per year (FIA or MSA approval required). In this case, the chassis/monocoque may only be modified in accordance with all the requirements in *Part III: Classification and Vehicle Specifications*.
- or be a steel tubular frame chassis incorporated in the safety cage in accordance with *Articles 39, 40 and 41*.

52.8.1 The body of the vehicle must be from the model range of the make of vehicle specified in the Technical Passport. The standard body profile side view proportions from the front of the grille, bonnet, and fenders to the rear of the crew cab and to the rear of the load body must be retained. The same applies to the plan view, front view, and rear view. The modifications are allowed in the spirit of retaining the production vehicle appearance, i.e., the standard body profile proportions must be retained.

- a) The standard windscreen aperture and rake must be maintained.
- b) The standard headlights and radiator grille to be retained and mounted in standard lay-out.
- c) The horizontal distance from the base of the windscreen to the front edge of the bonnet, may not exceed the standard vehicle dimension. To be measured on the vehicle centreline, with the sills set level.
- d) The vertical distance between the base of the windscreen and the horizontal centre of the headlight/grille assembly may not be less than the standard vehicle dimension. To be measured on the vehicle centreline, with the sills set level.

e) The front and rear overhang dimensions are 660mm minimum and has to be maintained over a minimum lateral distance of 500mm around the centreline of the vehicle (250mm each side). The front and rear departure angles are free.

f) The front bumper, bonnet and fenders may be modified respecting a), b), c), d) and e), and must blend in with the windscreen, headlights, and grille in their original orientation to maintain the production vehicle appearance in standard body proportions.

g) The three (3) (side-, plan-, rear-) profiles of the cab and load body must reflect the profile proportions of the production vehicle.

h) The width and height of the crew cab may be increased from standard to comply with the FIA Regulations with the specific written permission of the Chairman.

The crew cab may be original steel modified or remanufactured in fiberglass composite with one covering layer of Carbon Fibre only for aesthetic purposes. *Refer ART 43.3.1.*

i) The front doors must remain in the original production material, be of the original shape and size and be fitted to the racing vehicle using the original steel hinges with all the steel bolts in their original positions bolted onto the steel chassis frame. The original door locks must be retained, opening from inside and outside. Window winding mechanisms may be removed, respecting *ART 49.22*.

j) A 75% portion of the interior flat area of the production door frame, as covered by the production interior cover, may selectively be cut away to lighten the door without affecting the structural rigidity of the door adversely. The doors must still provide sufficient protection for the occupants in the case of an accident.

k) Should the space below the floor of the crew cab be utilised for components and storage, the sills may be extended from the floor level downwards and laterally not wider than the maximum vehicle width of 2000mm blending into the wheel arch extensions.

l) The standard doors may be shortened at the bottom by up to 200mm, to accommodate the larger cab sills, respecting paragraphs j) and k) and remaking the bottom portion of the door frame in steel.

- m) All window openings other than the cab rear window must be retained in their original position and be of the original size and shape. These windows other than the front door windows may be transparent, open, or opaque. *Refer Art 49.22.*
- 52.8.2 The maximum width of the vehicle is two (2) meters, excluding the rear-view mirrors. The wheel arches and the cab sills may be extended to this maximum of two (2)-meter overall width by the use of fender flares and laterally extended sills. The wheel arches may be repositioned to accommodate the wheelbase and overhang specified. Seen in vertical projection, the body work must cover at least 120° of the upper circumference of the wheels situated above the wheel axis as viewed from the side. This width measurement must be checked with the ride height set at 300mm measured at the front under the sump guard, and the sills level. *Refer Addendum 1.*
- 52.8.3 Two air vents or two (2) bulges to accommodate approved under-bonnet modifications, may be added to the bonnet of a racing vehicle, however, these may not protrude more than 50mm above the modified base profile of the bonnet.
- 52.8.4 Air ducting to rear mounted water radiators may be fitted on the passenger cabin roof but should follow the roof line to maintain the profile of the cabin. These additions are subject to the specific approval of the Commission in writing through the TC.
- 52.8.5 Vents or scoops may be added to the cabin roof for the purpose of providing ventilation for the Driver and Navigator. These vents must be blended to fit the roof profile.
- 52.8.6 The original body work sheet metal and hardware, onto which the headlights, radiator, and grille is mounted, may be removed, and replaced with a fabricated structure designed to perform the same function, providing none of the other provisions in these Regulations are contravened and the finished vehicle retains its original outward appearance.
- 52.8.7 The firewall between the engine compartment and the passenger compartment, along with the floor of the passenger compartment and the tunnel, which forms part of the floor, may be removed, and refabricated in order to accommodate authorised non-standard components, respecting *ART 39* Safety Belts and *ART 40* Seats and Seat mountings, and providing none of the other provisions in these Regulations are contravened and the finished vehicle retains its original outward appearance. The new tunnel, floor and firewall may be fabricated from steel or composite. A single layer of carbon will be allowed on the top side of the tunnel, floor, and firewall for aesthetic purposes. The TC / Chief Scrutineer reserves the right to drill a 30mm hole with a hole saw in a place of his discretion to analyse the composition of the components. *Refer ART 43.3.1 & 43.3.2.*
- 52.8.8 The production dashboard may be retained or remade in a similar shape and size in an alternative material which is non-metallic. All other trim should be removed. *Refer ART 43.3.1.*
- 52.8.9 Competitors intending to convert station wagons, SUV's, panel vans etc. must obtain the prior approval of the Controllers through the TC / Chief Scrutineer and be briefed on the Commission's specific interpretation of the Class S Rules and how they will apply to such vehicles.
- 52.8.10 The floor pan behind the crew may be cut and modified or remade to accommodate the fuel tank. The fuel tank and fuel lines must be separated from the cockpit by a liquid and fireproof bulkhead. *Refer Art 37.*
- 52.9 **Fuel System** - *Refer Art 37.*
- 52.9.1 The fuel tank size is free.
- 52.9.2 Fuel feed pumps are free.
- 52.9.3 Fuel coolers of the air to fuel type are authorised in the return lines.
- 52.10 **Electrical System**
- 52.10.1 Battery size, type, and location – free. *Refer Art 38.*
- 52.10.2 Wiring harness - free.
- 52.10.3 Lights - *Refer Art 38.*
- 52.11 **Cooling System**
- 52.11.1 The engine cooling water radiator/s and position is free. The addition of electric water pumps to aid water cooling is authorised. The addition of ducting components to improve airflow through the radiator is authorised.
- 52.11.2 Transmission coolers – free
- 52.11.3 Power steering coolers – free
- 52.11.4 All coolers and ducting must be housed within the standard bodywork profiles. Minimal cutting of internal bodywork only is allowed to accommodate the fitting of these systems.

53 CLASS D | PRODUCTION BASED VEHICLES WITH CHASSIS, 4 LITRES

53.1 Engine

53.1.1 Naturally aspirated petrol engines with four cylinders or more, and a maximum capacity of 4000cc, or alternatively, a Turbo Diesel Engine with a maximum capacity of 3200cc.

53.1.2 All Class D Vehicles must be fitted with Group N specification engines from the same marque of the body and chassis.

53.1.3 The turbo charger fitted to a diesel engine selected must be homologated.

53.1.4 Exhaust manifold and exhaust system is free.
Refer Art 34.

53.1.5 Flywheel to be original, or made of ferrous material only, otherwise free.

53.1.6 Engine mountings are free; however, the engine must remain in its original position. The attachment of the mounts to the engine block must be to the standard position.

53.1.7 Cooling systems for engine water, lubrication oil, power steering, gearbox and transmission oil are free, except that the bodywork Regulations must be respected. Water radiator must be retained in its original area as in the production vehicle, e.g., in front of the engine.

53.1.8 Air cleaner system and position is free.

53.1.9 Air conditioners and heaters may be removed.

53.1.10 Piggyback, remapped, and direct replacement ECU's are permitted. The engine wiring harness, connectors and sensors are free. The air mass sensor is free. The air valve may be enlarged provided it is still housed within the standard throttle body. *Refer Art 43.5.*

53.1.11 No telemetry is permitted. *Refer ART 43.8.* No traction control systems or devices are permitted. *Refer ART 43.5.*

53.1.12 Diesel engine intercoolers must comply with ARTS 33.2.3, 33.2.4 & 33.2.5.

53.2 Transmission/Driveline

53.2.1 Drive 2x4 or 4x4.

53.2.2 Clutch and pressure plates are free but are restricted to a maximum of twin plates. Carbon friction plates are not allowed.

53.2.3 Gearbox may be replaced with any unit from the model range of the vehicle, or a Controllers Approved gearbox. Gearbox mountings are free.

53.2.4 Transfer case may be replaced with any unit from the model range of the vehicle, internals free or a Controllers Approved unit. Transfer case mountings are free.

53.2.5 Axle housings from the same model range as the vehicle may be used including rear housings being used in front and front axle housings being used at rear. Axle housings may be reinforced.

53.2.6 Internal axle components are free, including drive shafts but ferrous materials only.

53.2.7 Prop shafts and centre bearings are free but ferrous materials only.

53.3 Brake System

53.3.1 Standard braking system or disc brakes front and rear from a production vehicle – Controllers Approved. A Racing pedal box system may be fitted to replace the standard system. Friction material is free.

- Hand brake system is free.

- Brake bias valve may be added to the standard system.

- Brake tubing / hoses and location free provided the quality is better or equivalent to the original.

53.4 Electrical System

53.4.1 Battery size, type and location are free.

53.4.2 The rest of the system is free provided it complies with the safety standards. *Refer Art 38.*

53.5 Suspension

53.5.1 The original suspension pick-up positions must be retained. Use of the original pick-up brackets on the chassis is preferred, with additional reinforcing.

53.5.2 Spring rates, torsion bar diameters as well as the free camber height of leaf springs are free.

53.5.3 Shock absorbers as well as their mounting / location are free.

53.5.4 Bump stops are free including the use of hydraulic bump stops.

53.5.5 Suspension bush materials are free.

53.5.6 Dual or any form of additional suspension medium is not permitted.

53.5.7 Suspension travel maximum for front suspension 250mm. Suspension travel maximum for rear suspension 300mm. Method of measurement. *Refer Art 32.6.*

53.5.8 Anti-tramp rods may be added but these are restricted to one per side. *Refer Art 32.8.*

53.5.9 Leaf springs may be replaced with coil springs. As per the layout below.

53.5.10 Rear Suspension

All Class D vehicles may be converted to a live rear axle system, regardless of the original arrangement fitted to the vehicle selected. Independent rear suspension will not be allowed.

Live rear axles must be modified to a four (4)-link system with coil springs and telescopic dampers. The upper arms of the system shall be A-arm type only. The upper A-arm and lower arms are of free design, but ferrous materials only may be used. The only area that this suspension system may occupy is 1.2 metre ahead of the new rear axle centre line and 250mm behind the new axle centre line and one metre above the ground at the specified ride height of 300mm.



53.5.11 Front suspension

- Ball joints are free but must come from a production vehicle.
- Top wishbone is free, but design must be Controllers Approved for each, make and model.
- Bottom wishbone must be standard but may be reinforced.
- Standard uprights must be retained but may be reinforced.
- Steering rack or steering box must be standard, or Toyota Land Cruiser or production based, Controllers Approved unit.
- All steering links and joints are free.

53.6 **Rims/Tyres**

Rims are free provided they do not protrude past the width of the standard body. At least one third of the plan view of the tyre must be covered by the wheel arch bodywork when viewed from above. Tyres, Refer 49.18.

53.7 **Chassis**

- 53.7.1 Standard production chassis of the same model as body and engine.
- 53.7.2 Chassis may be reinforced provided the original silhouette is retained.
- 53.7.3 Mounting points for roll cage, fuel tanks and other items may be added.
- 53.7.4 The chassis rail, in excess of 600mm, ahead of the centre line of the front wheel, may be removed. The rear part of the chassis may be removed from a point, no further forward, than 250mm in front of the centre of the rear axle for the coil sprung live axle conversion only. The chassis rail width shall remain as standard.

53.7.5 Unused mounting points for original items such as shock absorbers, exhaust, load body, fuel tank and spare wheel may be removed.

53.7.6 One rear cross member may be removed or relocated to accommodate the fuel tank or spare wheels.

53.8 **Body**

53.8.1 This Class is for bakkies and SUV's only.

The body must be from the same model range as the chassis. The standard body profile side view, from the front of the grille, bonnet, and fenders to the rear of the cab must be retained. The same applies to the plan view, front view, and rear view. The front bumper may be replaced by a fiberglass replica, modified below the height of the top of the wheel, *Refer Addendum 1*.

The replica front bumper must blend in with fenders, lights, and grille to maintain the production vehicle appearance. The body must be maintained in its original position on the chassis from all points of view, i.e., height, longitudinal and lateral position.

53.8.2 All interior trim and door panels may be removed.

53.8.3 The production dashboard may be retained or remade in a similar shape and size in an alternative material which is non-metallic. All other trim should be removed. *Refer ART's 43.3.1 & 43.3.2*.

53.8.4 Seats shall be replaced with FIA approved types. Seat mountings shall be FIA approved or comply with FIA requirements. *Refer Art 39 and 40*.

53.8.5 Rear seats may be removed.

53.8.6 Windows. *Refer Art 38.1*.

53.8.7 Bonnet and fenders may be replaced with fiberglass replicas, provided the original shape and profile are retained.

53.8.8 The load body of a bakkie may be removed, provided the side panels or fiberglass replicas of the panels are retained. The load body panels may be modified inside view to suit the wheelbase and exit angle. Refer Addendum 1 for specifications.

53.8.9 Vents or scoops may be added to the roof for ventilation. Where additional vents and scoops are required for functional reasons to aid cooling, these additions are subject to the specific approval of the commission through the TC / Chief Scrutineer, in writing.

53.8.10 The standard fenders may not be flared. Commercially available over-fenders may be fitted.

53.8.11 A bakkie rear cab window may be replaced with polycarbonate type material, minimum 3 mm thick. *Refer ART 35.3*

53.9 Fuel System

53.9.1 Fuel tank, capacity and location are free. Fuel tank construction as well as the mounting thereof shall be approved by the TC / Chief Scrutineer. *Refer Art 37.*

53.9.2 Fuel filters, pumps and pipes are free.

53.10 Crew

Two crew members.

53.11 Minimum Weight and Inlet Air Restrictors

53.11.1 Minimum weight:

Minimum weight for petrol powered vehicles
1750kg

Minimum weight for Diesel powered vehicles
1800kg

53.11.2 Inlet air restrictor

- Petrol engines 35 (thirty-five) mm
- Turbo Diesel engines 37(thirty-seven) mm

54. CLASS E | PRODUCTION BASED VEHICLES WITH CHASSIS, 3.0 LITRE

54.1 Engine

54.1.1 Four (4) Cylinder naturally aspirated petrol or turbo charged diesel.

Maximum actual engine capacity not to exceed 3000cc, petrol or diesel.

54.1.2 The engine must be from the same model range as the body and chassis.

54.1.3 All vehicles completed after 1 December 2010, must be fitted with Group N specification engines.

54.1.4 The original turbo unit must be retained.

54.1.5 All vehicles selected to run in this Class that are fitted with fuel injection as standard, must retain the standard system. The system includes the inlet manifold and standard throttle body. The air valve may be enlarged provided it is still housed within the standard throttle body. Internal porting and metal removal only is allowed.

54.1.6 Intake manifold for carburettors are free.

54.1.7 Exhaust manifold and exhaust systems are free.

54.1.8 Flywheel to be original, or made of ferrous material only, otherwise free.

54.1.9 Engine mountings are free provided the engine retains its original position in all directions. The attachment of the mounts to the engine block must be to the standard position.

54.1.10 Water radiator is free but must retain its original position in all directions.

54.1.11 Air cleaner system and position is free.

54.1.12 Air conditioners and heaters may be removed.

54.1.13 Piggyback, remapped, and direct replacement ECU's are permitted. The engine wiring harness, connectors and sensors are free. The air mass sensor is free. No telemetry is permitted. No traction control systems or devices are permitted. *Refer ART 43.5.*

54.2 Transmission/Drive Line

54.2.1 Drive 2x4 or 4x4.

54.2.2 Clutch and pressure plates are free but are restricted to a maximum of twin plates. Carbon friction plates are not allowed.

54.2.3 Gearbox may be replaced with any unit from the model range of the vehicle.

54.2.4 Transfer case mountings are free, as are the internals.

54.2.5 Front diff output shafts are free. Ferrous materials only.

54.2.6 Front drive shafts are free. Ferrous materials only.

54.2.7 Axle housings from the same model range as the vehicle may be used including rear housings being used in front and front axle housings being used at rear. Axle housings may be reinforced.

54.2.8 Internal axle components are free. Ferrous materials only.

54.2.9 Prop shafts and centre bearings are free. Ferrous materials only.

54.3 Brake System

54.3.1 Standard braking system or disc brakes front and rear from a production vehicle – Controllers Approved. A Racing pedal box system may be fitted to replace the standard system.

54.3.2 Friction material is free.

54.3.3 Hand brake system is free.

54.3.4 Brake bias valve may be added to the standard system.

54.3.5 Brake tubing / hoses and location free provided the quality is better or equivalent to the original.

54.4 Electrical System

54.4.1 Battery size, type and location are free. The rest of the system is free provided it complies with the safety standards. *Refer ART 38.*

54.5 Suspension

54.5.1 The original suspension mounting points must be retained but may be reinforced.

54.5.2 Spring rates, torsion bar diameters as well as the free camber height of leaf springs are free.

54.5.3 Original suspension components may be reinforced only and may not be changed.

54.5.4 Shock absorbers and their mounting points of shock absorbers are free.

54.5.5 Bump stops are free, including the use of hydraulic bump stops.

- 54.5.6 Suspension bush materials are free.
- 54.5.7 Dual or any form of additional suspension medium is not permitted.
- 54.5.8 Suspension travel maximum for front suspension 250mm. Suspension travel maximum for rear suspension 300mm. Method of measurement Refer Art 32.6.
- 54.5.9 Anti-tramp rods may be added. *Refer Art 32.8.*
- 54.5.10 Leaf spring suspension at the rear must be retained.
- 54.6 Rims/Tyres**
- 54.6.1 Rims are free provided they do not protrude past the width of the standard body. At least one third of the plan view of the tyre must be covered by the wheel arch bodywork when viewed from above. Tyres, *Refer ART 49.18.*
- 54.7 Steering**
- 54.7.1 Power steering is permitted.
- 54.7.2 A steering box or steering rack fitted as standard may be replaced with a Toyota Hilux or Land Cruiser unit.
- 54.7.3 All steering links and joints are free.
- 54.8 Chassis**
- 54.8.1 Standard production chassis of the same model range as the body and engine.
- 54.8.2 Chassis may be reinforced provided the original silhouette is retained.
- 54.8.3 Mounting points for roll cage, fuel tanks and other items may be added.
- 54.8.4 Bush bars, rear bumper and protective/skid plates may be added.
- 54.8.5 No part of the original chassis rail may be removed.
- 54.8.6 For monocoque construction vehicles the total monocoque must be retained and only reinforcing is permitted.
- 54.8.7 Unused mounting points for original items such as shock absorbers, exhaust, load body, fuel tank and spare wheel may be removed.
- 54.8.8 One rear cross member may be removed or relocated to accommodate the fuel tank or spare wheels.
- 54.9 Body**
- 54.9.1 The body must be from the same make and model range as the chassis. The standard body profile side view from the front of the grille, bonnet, and fenders to the rear of the cab must be retained. The same applies to the plan view, front view, and rear view. The front bumper may be replaced by a fiberglass replica, modified below the height of the top of the wheel. Refer Addendum 1. The replica front bumper must blend in with fenders, lights,

- and grille to maintain the production vehicle appearance. The body must be retained in its original position on the chassis from all points of view, i.e., height, longitudinal and lateral position.
- 54.9.2 All interior trim and door panels may be removed. The production dashboard may be retained or remade in a similar shape and size in an alternative material which is non-metallic. All other trim should be removed. *Refer ART's 43.3.1 & 43.3.2.*
- 54.9.3 Crew seats shall be replaced with FIA approved types. Seat mountings shall be FIA approved or comply with the FIA requirements. Refer Art 39 and 40.
- 54.9.4 Rear seats may be removed.
- 54.9.5 Windows. *Refer ART 49.22.*
- 54.9.6 Bonnet and fenders may be replaced with fiberglass replicas, provided the original shape and profile are retained.
- 54.9.7 The load body of a bakkie may be removed, provided the side panels or fiberglass replicas of the panels are retained. The load body panels may be modified in side view to suit the wheelbase and exit angle. Refer Addendum 1 for specifications.
- 54.9.8 A station wagon rear and side windows may be removed or replaced with fiberglass or aluminium panels.
- 54.9.9 The floor or the rear body section of a station wagon may be removed, provided there is a firewall between the occupants and the fuel tanks. Refer Art 37.
- 54.9.10 Vents of scoops may be added to the roof for ventilation.
- 54.9.11 The fenders may not be flared.
- 54.9.12 A station wagon rear doors may be removed.
- 54.9.13 A bakkie rear cab window may be replaced with polycarbonate type material.
- 54.10 Fuel System**
- 54.10.1 Fuel tank, capacity and location are free. Fuel tank construction as well as the mounting thereof shall be approved by the TC / Chief Scrutineer. Refer Art 37.
- 54.10.2 Fuel filters pumps and pipes are free
- 54.11 Crew**
- Two crew members.
- 54.12 Minimum weights and inlet air restrictors**
- 54.12.1 Weight 1700kg
- 54.12.2 Inlet air restrictors
- | | |
|---------------------|-------------------|
| Petrol engine | Exempt |
| Turbo diesel engine | 39(thirty nine)mm |

56 CLASSIC CLUB CLASS

NOTE: Vehicles entered in this Class will be required to comply *with ART's 31 - 41 and ART 48.1*

- 56.1 This Class is for Off-Road racing vehicles built and raced in South Africa prior to 1999.
- 56.2 The Controllers reserve the right where necessary to imposed additional Regulations, and/or restrictions, to ensure fair and safe competition.

Addendum 1 Bodywork

Silhouette formula – Only change to silhouette where specified

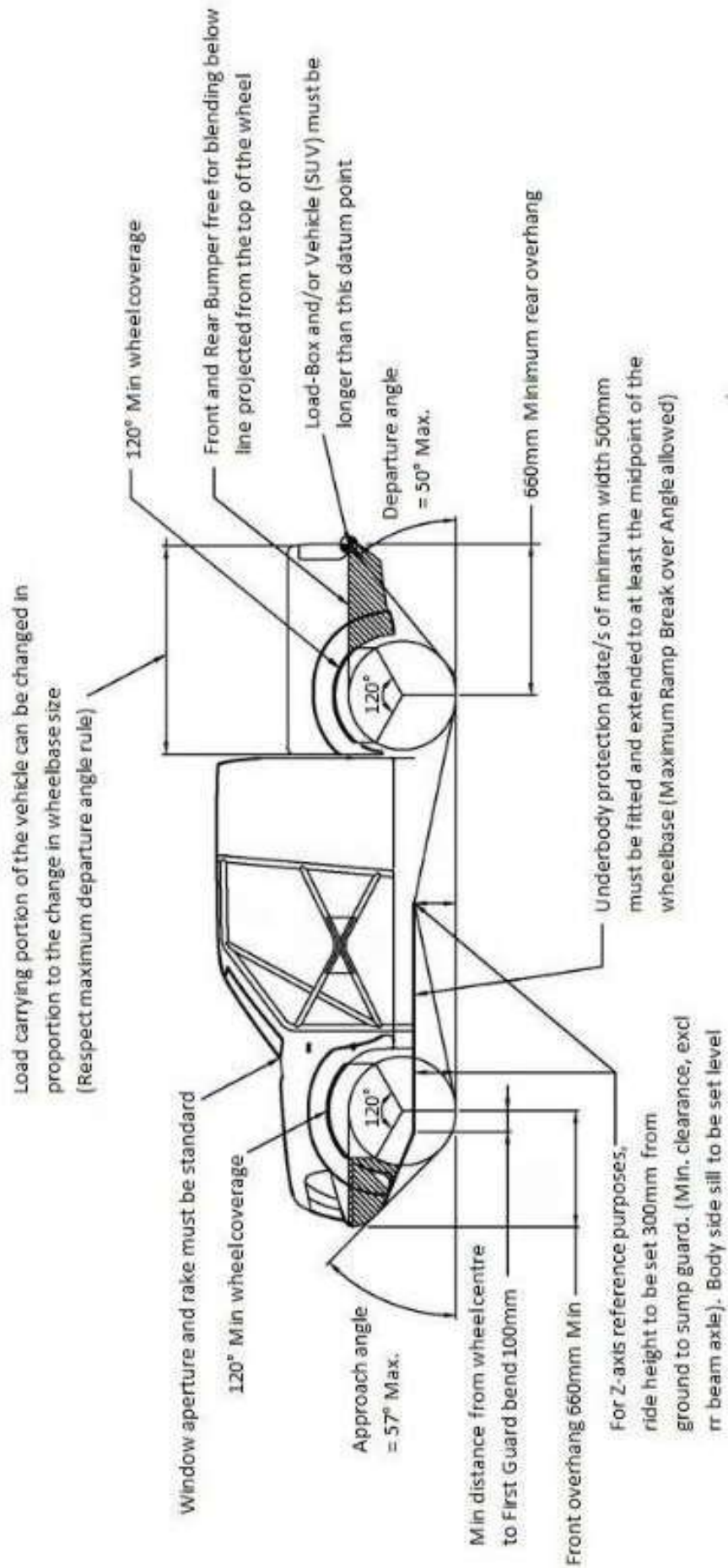

Addendum 2 Suspension

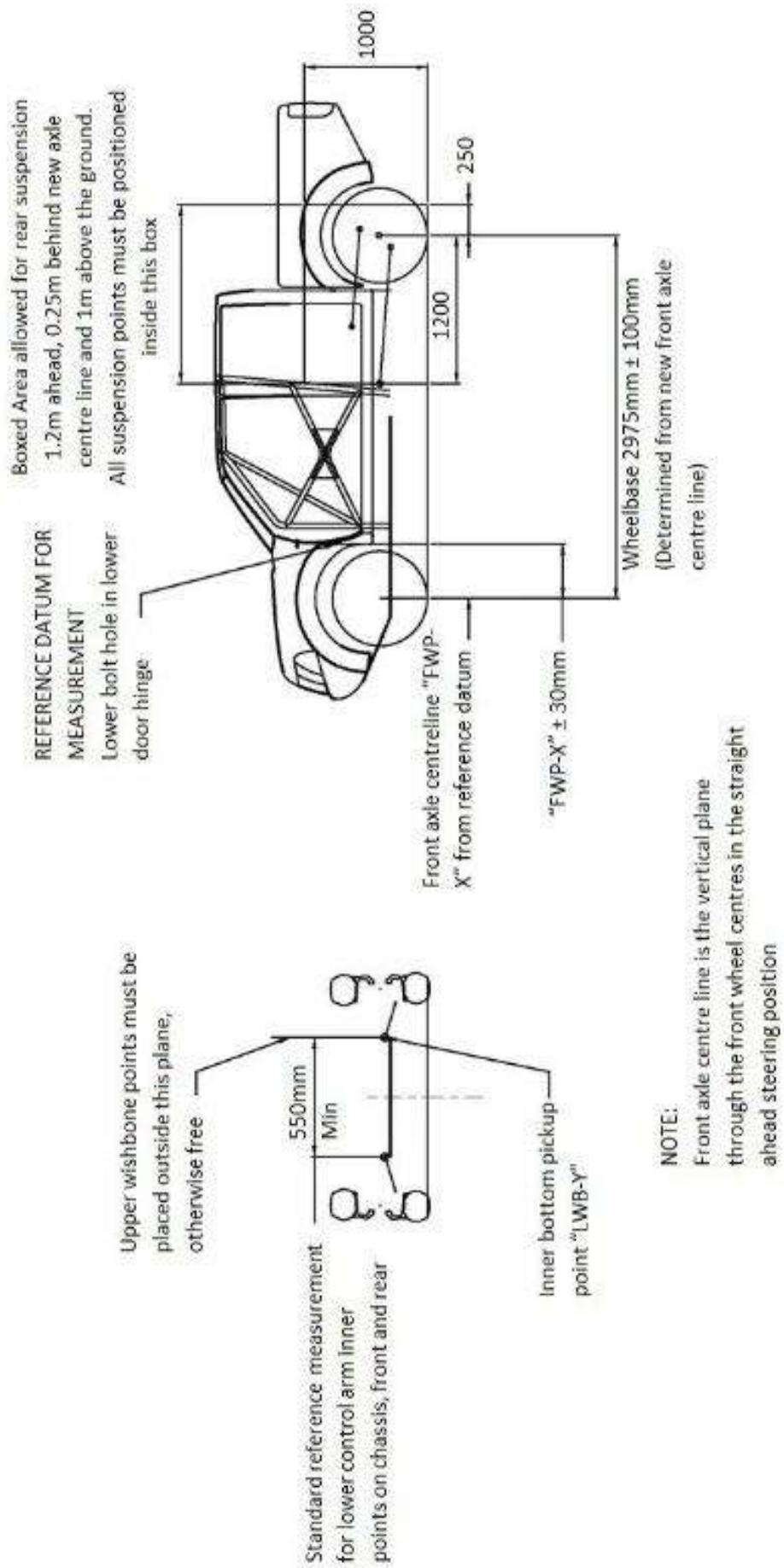

Addendum 3 Engine Position

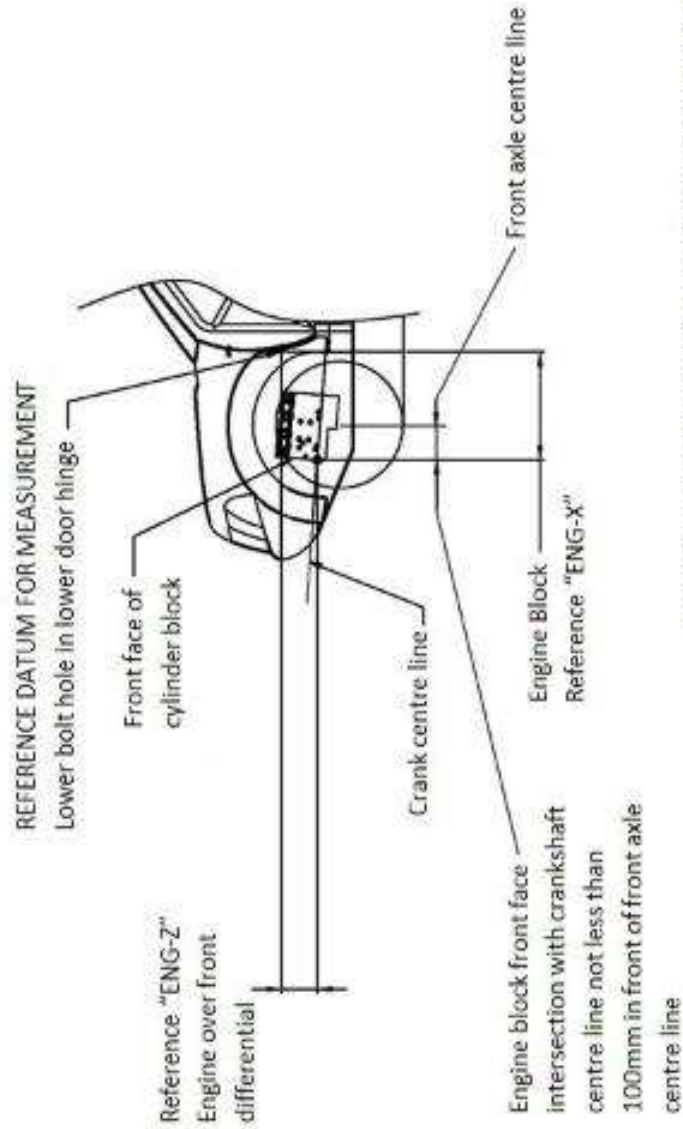

Relative to the original engine specified the following applies:
(Reference is the fitted engine mounted as original)
Note 1: Engine may be rotated around the crank axis $\pm 5^\circ$
Note 2: Engine may be moved left or right to facilitate fitment
Note 3: The height of the rear of the engine is free

MASTER DIMENSIONS TABLE	
VEHICLE MAKE	
VEHICLE MODEL	
VEHICLE MANUFACTURE YEAR	
ENGINE MAKE AND MODEL	
ENGINE: X	
ENGINE: Z	
FRONT WHEEL POSITION: "FWP-X"	
LOWER WISHBONE POSITION: "LWB-Y"	
WHEELBASE	
FRONT OVERHANG	
REAR OVERHANG	